

DOCUMENT RESUME

ED 288 848

SP 029 621

**TITLE** Dental Health Education Curriculum Guide for Use With Head Start Children and Families.

**INSTITUTION** American Dental Association, Chicago, Ill.

**SPONS AGENCY** Administration for Children, Youth, and Families (DHHS), Washington, DC. Head Start Bureau.

**REPORT NO** DHHS-OHDS-86-31535

**PUB DATE** 85

**NOTE** 156p.

**PUB TYPE** Guides - Classroom Use - Guides (For Teachers) (052)

**EDRS PRICE** MF01/PC07 Plus Postage.

**DESCRIPTORS** \*Curriculum Development; \*Dental Health; Eating Habits; Elementary Education; Health Education; \*Learning Activities; Parent Teacher Cooperation; Physician Patient Relationship

**IDENTIFIERS** Project Head Start

**ABSTRACT**

This teaching guide for a dental health curriculum for children in the Head Start Program contains lesson plans for the following areas: (1) introduction to the dental health program; (2) visiting the dentist; (3) awareness of the mouth; (4) the important functions of the mouth; (5) the importance of keeping teeth and gums clean; (6) toothbrushing; (7) the importance of fluoride and sealants; (8) wise food choices for a healthy mouth; (9) keeping teeth safe; and (10) reinforcement activities for dental health. Each lesson contains the following sections: (1) purpose of the lesson; (2) materials needed; (3) background information for the teacher; (4) starting the lesson; (5) classroom activities; (6) lesson review; and (7) a letter for parents. A resource list of organizations to contact for more information about dental health is included, as well as home visit activities to involve parents and information on caring for the disabled child's dental health. Also included is a questionnaire for use with Head Start families. (JD)

\*\*\*\*\*  
 \* Reproductions supplied by EDRS are the best that can be made \*  
 \* from the original document. \*  
 \*\*\*\*\*

**U.S. DEPARTMENT OF HEALTH AND HUMAN SERVICES**

Office of Human Development Services  
Administration for Children, Youth and Families  
Head Start Bureau



ED288848

# HEAD START

## Dental Health Curriculum

**SCOPE OF INTEREST NOTICE**

The ERIC Facility has assigned this document for processing to:

SP

In our judgment, this document is also of interest to the Clearinghouses noted to the right. Indexing should reflect their special points of view.

PS



**U.S. DEPARTMENT OF EDUCATION**  
Office of Educational Research and Improvement  
**EDUCATIONAL RESOURCES INFORMATION CENTER (ERIC)**

- This document has been reproduced as received from the person or organization originating it.
- Minor changes have been made to improve reproduction quality.

• Points of view or opinions stated in this document do not necessarily represent official OERI position or policy.

ED 029 621



**DENTAL HEALTH EDUCATION CURRICULUM GUIDE  
FOR USE WITH HEAD START CHILDREN AND FAMILIES**

## FOREWORD

We are pleased to make this Dental Health Curriculum, funded by the Head Start Bureau, available to Head Start programs throughout the nation. The curriculum, developed especially for teachers to use in the classroom and with parents, will be a valuable tool in promoting the dental health of children. Use of the curriculum will enhance the child's awareness of the importance of tooth brushing after meals, and regular dental care. It will also help promote positive dental health attitudes and habits.

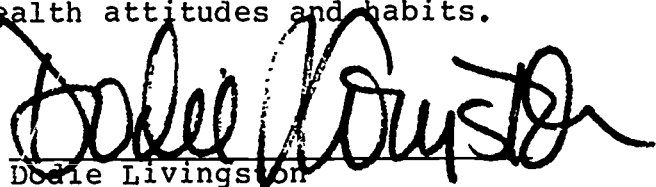

Dede Livingston  
Commissioner, Administration for  
Children, Youth and Families

## CONTENTS

Acknowledgments	iii
Foreword: To the Teacher	v

### LESSONS

Introduction of "Smiley the Super Pup"	1
Visiting the Dentist	5
Awareness of the Mouth	19
The Important Functions of the Mouth	25
The Importance of Keeping Teeth and Gums Clean	33
Toothbrushing	40
The Importance of Fluoride and Sealants	53
Wise Food Choices for a Healthy Mouth	62
Keeping Teeth Safe	76
Reinforcement Activities for Dental Health	83
Resources	90
Home Visit Activities	92
Your Role in Helping Children With Disabilities	94
United States Public Health Service Regional Head Start Dental Directors	97
Questionnaire	99

## ACKNOWLEDGMENTS

The Dental Health Education Curriculum was developed by the American Dental Association's Bureau of Health Education and Audiovisual Services through a grant funded by the Head Start Bureau. The grant was administered by the Division of Maternal and Child Health, Bureau of Health Care Delivery and Assistance, Health Resources and Services Administration, United State Public Health Service, Department of Health and Human Services.

A special note of thanks and appreciation is due the staff at the Bureau of Health Education and Audiovisual Services, American Dental Association, for their professional expertise in this project: Mr. Randall Grove, Director; Ms. Susan Seffrin, Assistant Director; Ms. Mary A. Banas, Ms. Denise S. LeBloch, and Mr. Richard J. Walther.

Grateful acknowledgement is also made to the following professional colleagues for their guidance and assistance in the project: Public Health Service - Ms. Annie Barnes, Mr. William Beacham, Dr. William Hall, Dr. Vince Hutchins, Ms. Mary Beth Kinney, Ms. Susan Lockhart, Dr. Michael Roberts, and Dr. William Warren; Head Start Bureau, Central Office Staff - Ms. Pamela Coughlin, Dr. Marguerite Mazique, Dr. Phyllis Stubbs, Dr. Margaret Phillips, Mr. Clint Mitcham, Mr. Clennie Murphy, Ms. Marion Slatin and Mrs. Josie Reifsnyder.

Special recognition is extended to the following Regional Head Start Dental Directors and to other individuals who served as consultants for this project:

Cheryl Aiello, M.S.H.P.  
Linda Banas, Clerical  
Coordinator  
Earnestine Bernard, Head Start  
Program Director  
Pamela Bobst, G.D.H., B.A.  
Linda Brown, Head Start  
Teacher  
Karen Calhoun, Head Start  
Program Education Coord.  
Susan Cohen, R.D.H.  
Sherman Cox, D.D.S., M.P.H.  
Deborah Deatrack, M.S.P.H  
Pam Edd, R.D.H., M.S.  
John Elliott, D.D.S., M.P.H.  
Caswell Evans, D.D.S., M.P.H.  
Jan Goldsmith, D.M.D., M.P.H.  
Jerry Gribble, D.D.S., M.P.H.  
Claud Haisley, D.D.S., M.P.H.  
William Hall, D.D.S., M.P.H.  
Richard Hastreiter, D.D.S.,  
M.P.H.  
Susan M. Hegland, Ph.D.  
Margaret Hinkle, M.S., R.D.  
Mildred H. Jackson, R.D.H.,  
M.P.H.  
Dora Jauregui, Child Care  
Professional

Mary Beth Kinney, Dental  
Education Specialist  
Anthony Kiser, D.D.S., M.P.H.  
Raymond A. Kuthy, D.D.S.,  
M.P.H.  
Robin M. Lawrence, D.D.S.,  
M.P.H.  
Martin MacIntyre, D.D.S.,  
M.P.H.  
Joan M. McGowan, R.D.H., Ph.D.  
Trudy McNulty, R.D.H.  
Sharon Molargik, Head Start  
Program Director  
Symphony O'Keefe, R.N., M.Ed.  
Connie O'Meara, R.D.H.  
Holly Owens, Head Start  
Program Director  
Elizabeth Russell  
Robert Selwitz, D.D.S., M.P.H  
Charles E. Smith, D.D.S.,  
M.P.H.  
Anita Spainhower, Head Start  
Teacher  
Sue Story, Head Start Programs  
Manager  
Lawrence Walker, D.D.S., M.P.H.

Finally an expression of appreciation is made to Mrs. Sharon Molargik, Director of the Garrett, Indiana Head Start Program, and Mrs. Earnestine Bernard, Director of the Michigan City, Indiana, Head Start Program for their invaluable assistance and cooperation in preliminary piloting of lessons from this Dental Health curriculum in their Head Start classrooms.

Robert W. Beck, D.D.S., M.P.H.  
Project Director, Dental Head Start  
United States Public Health Service  
1985

## FOREWORD: TO THE TEACHER

There are many ways you can provide meaningful learning experiences about dental health that can help your Head Start children develop good attitudes and habits. Learning about good dental health care at an early age can help children throughout their lives. Dental disease can be prevented and healthy teeth can last a lifetime.

This teaching guide has been prepared to assist you in conducting dental health lessons that can help your Head Start children develop an understanding of the importance of their teeth and of ways to keep a healthy mouth.

The guide contains lesson plans for the following areas:

- \*Introduction to the Dental Health Program
- \*Visiting the Dentist
- \*Awareness of the Mouth
- \*The Important Functions of the Mouth
- \*The Importance of Keeping Teeth and Gums Clean
- \*Toothbrushing
- \*The Importance of Fluoride and Sealants
- \*Wise Food Choices for a Healthy Mouth
- \*Keeping Teeth Safe
- \*Reinforcement Activities for Dental Health

### NOTE:

The introductory lesson is provided to introduce the children to a puppet character, "Smiley, the Super Pup," who is used at the end of every lesson to review the concepts that have been presented. Although the use of the puppet is optional, as each lesson can be presented without it, it is felt that the puppet will provide a fun way to review each lesson and will help the children connect all the areas of dental health that are presented in the curriculum. A pattern for making Smiley is included in the introductory lesson.

Depending on your particular situation, you may choose to change the order of some of the lessons. The "Visiting the Dentist" lesson was placed first because Head Start children often have their first dental visit in the beginning of the Head Start year. In these instances, it is important for the children and their parents to become familiarized with what occurs during a dental visit so they will not be fearful of the experience.



Each lesson contains the following sections:

Purpose - This section provides information for the teacher on why the lesson is presented and what the lesson hopes to accomplish.

Materials Needed - This section indicates what items you will need, such as:

- \*felt, old magazines, construction paper, crayons, etc.
- \*the activity pages (found at the end of each lesson) that need to be duplicated for use during the lesson
- \*parent letters (also found at the end of each lesson) and any other information that should be duplicated and sent home to parents.

Background Information for the Teacher - This section provides detailed information about specific dental health topics to help the teacher present the lesson.

Starting the Lesson - This section provides specific ways to start each lesson. It includes discussion questions to ask the children to help them develop a foundation for the dental health information that will be presented to them.

Classroom Activities - This section provides activities to conduct with the children to help reinforce the dental health information that has been presented to them. Many of the activities involve other areas of the curriculum, such as music, art, counting, and language arts. This presents an opportunity to integrate the dental health lessons with other areas of the Head Start curriculum.

Lesson Review, Puppet Story (Optional) - This section provides an opportunity to review the lesson by using the character "Smiley, the Super Pup" in a puppet story. The puppet story scripts are written so as to involve the children by asking questions to which they may respond.

Parent Letter - A letter for parents is provided at the end of each lesson. It may be duplicated and sent home with every child to inform parents of the dental health lesson that has been presented at Head Start. You may sign the letter, cut off the lesson title, and duplicate a copy for each child to take home, or you may rewrite the letters, adding information that especially relates to your classroom. In some lessons there are special information pages for copying and attaching to the parent letter.

Included at the end of the guide is:

- \*A Resource List of organizations to contact for more information about dental health.
- \*Home Visit Activities to provide ideas of ways to involve parents in dental health activities for their families.
- \*Information on caring for the disabled child's dental health.

Each of the lessons may take several days or even weeks to complete, depending on your Head Start class and the amount of time you spend on each activity. Within each lesson there are suggestions for statements you may say to the children and questions to ask them. These may, however, be changed by you according to what you believe is most easily understood by your Head Start class. Whenever possible, you are encouraged to add activities or change those suggested so that they will be most meaningful for the children with whom you are working, given their specific background, their previous experiences, and their family lifestyle.

Pages of the manual are perforated and have holes punched in them so they will fit into a three-ring binder. This has been done to enable you to remove pages that you wish to duplicate and then replace them so that all lesson pages may be kept together in a binder. Before you cut out a pattern or color an activity page, be sure that the original page has been returned to your manual so you will be able to use it again. It is suggested in some lessons that you copy activity pages, color them, and mount them on heavy paper to make them sturdier for handling. All pages are designed with black ink so that you may easily copy them.

It is hoped that this program will develop within Head Start children a good feeling about themselves and an awareness of the importance of good dental health. Be sure to encourage your children to participate in the activities and discussions. Provide them with positive reinforcement when they participate. Children learn best when they have a good self-image and are given an opportunity to actively participate in learning experiences without the threat of being wrong.

Please be sure to return the questionnaire found on the last page of this manual. Your feedback regarding this program and your ideas for other Head Start dental health education activities will be very useful in the future development of Head Start dental health education materials and programs.

DENTAL HEALTH EDUCATION CURRICULUM GUIDE  
FOR USE WITH HEAD START CHILDREN AND FAMILIES

LESSON:

INTRODUCTION OF "SMILEY, THE SUPER PUP" (Optional)

Purpose:



To introduce the children to a puppet character who will be used throughout the dental health lessons and to establish this new character as a friend who wants to help the children learn all about their teeth and mouth and how to take good care of themselves. The use of the puppet is optional. Each lesson can be presented with or without the use of "Smiley, the Super Pup."

Materials  
Needed:

Colored felt  
Buttons (optional)  
Needle and thread  
Scissors  
Glue  
Felt markers (permanent ink)  
Activity Page, "Smiley, the Super Pup" Pattern  
Activity Page, "Smiley Face"

Background  
Information  
for the Teacher:

Because children enjoy puppet stories, a puppet character, "Smiley, the Super Pup," has been designed to be used throughout the lessons on dental health.

These puppet stories have been developed to reinforce the concepts that have been introduced in each lesson. Each puppet story repeats the main ideas of the lesson and includes several questions for the puppet to ask the children. The questions are designed to be success-oriented so that more than one answer can be correct. Try to encourage a

variety of answers in order to involve as many students as possible.

The script of each puppet story provides you with a "working" model for use with the puppet. You should feel free, however, to change the wording, to repeat the questions in order to involve as many children as possible, or to drop any questions that seem inappropriate for your particular class.

Although the use of the puppet stories is optional, using "Smiley, the Super Pup" at the end of each lesson will help the children realize that the concepts of each lesson are all connected to one central theme -- dental health.

Before starting this introductory lesson, make "Smiley, the Super Pup" by using the patterns and instructions given on the activity page titled "Smiley, the Super Pup."

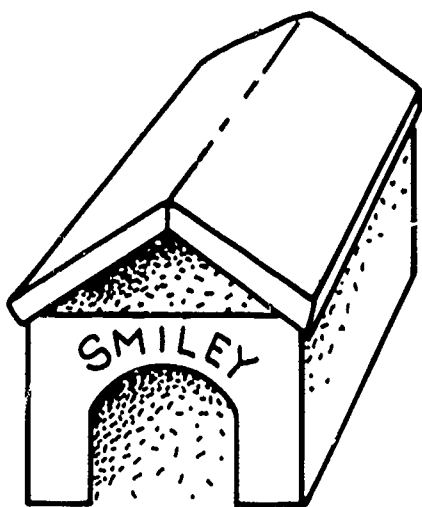

Suggestion for storing the puppet: Using a shoe box or any other box of similar size, make a dog-house in which to keep Smiley when not in use. Turn the box upside down and cut out an opening for the door. The top of a shoe box may be folded to form a V-shaped roof for the house. Depending on what art supplies are available, you may want to paint the box or cover it with paper.

Starting the Lesson:

Tell the children that you want them to meet a new friend. Have the children close their eyes while you get the "Smiley, the Super Pup" puppet and put it on your hand. Tell the children to open their eyes, and then say,



"This is a new friend of ours, Smiley, the Super Pup. Would you say 'hi' to Smiley?"

Move Smiley as though waving to the children, and using your own voice or one you make up especially for the character, say, "Hello, boys and girls. I'm glad to see you. My name is Smiley. Your teacher has told me that you are very special boys and girls. Can you give me a big smile? What terrific smiles you have! I feel lucky to be with you. We're going to have fun together learning about how to take good care of our teeth."

"I have to go now, but I will see you again soon. Bye!"

Put the puppet away until you are ready to use it in the next lesson. Tell the children that Smiley will be telling them lots of good stories about teeth.

**Classroom  
Activities:**

1. Rhythm Activity - teach the children the following rhythmic chant:

Smiley, the Super Pup, came to our room.

Smiley, the Super Pup, come again soon.

Smiley, the Super Pup, teach us to do,

Things that will make us smile like you.

2. Art Activity: Give each child a copy of Activity Page, "Smiley Face." Have children point to the dog's eyes. Have children point to the dog's nose. Have children point to the dog's teeth. Have children count the dog's top

teeth. Distribute crayons to the children so they can color their dog picture.

Note:

You may want to discuss with the children that some dogs are nice, friendly dogs, and some dogs are not nice and friendly. Explain to the children that they should not pet dogs unless they know the dog is a nice, friendly dog.

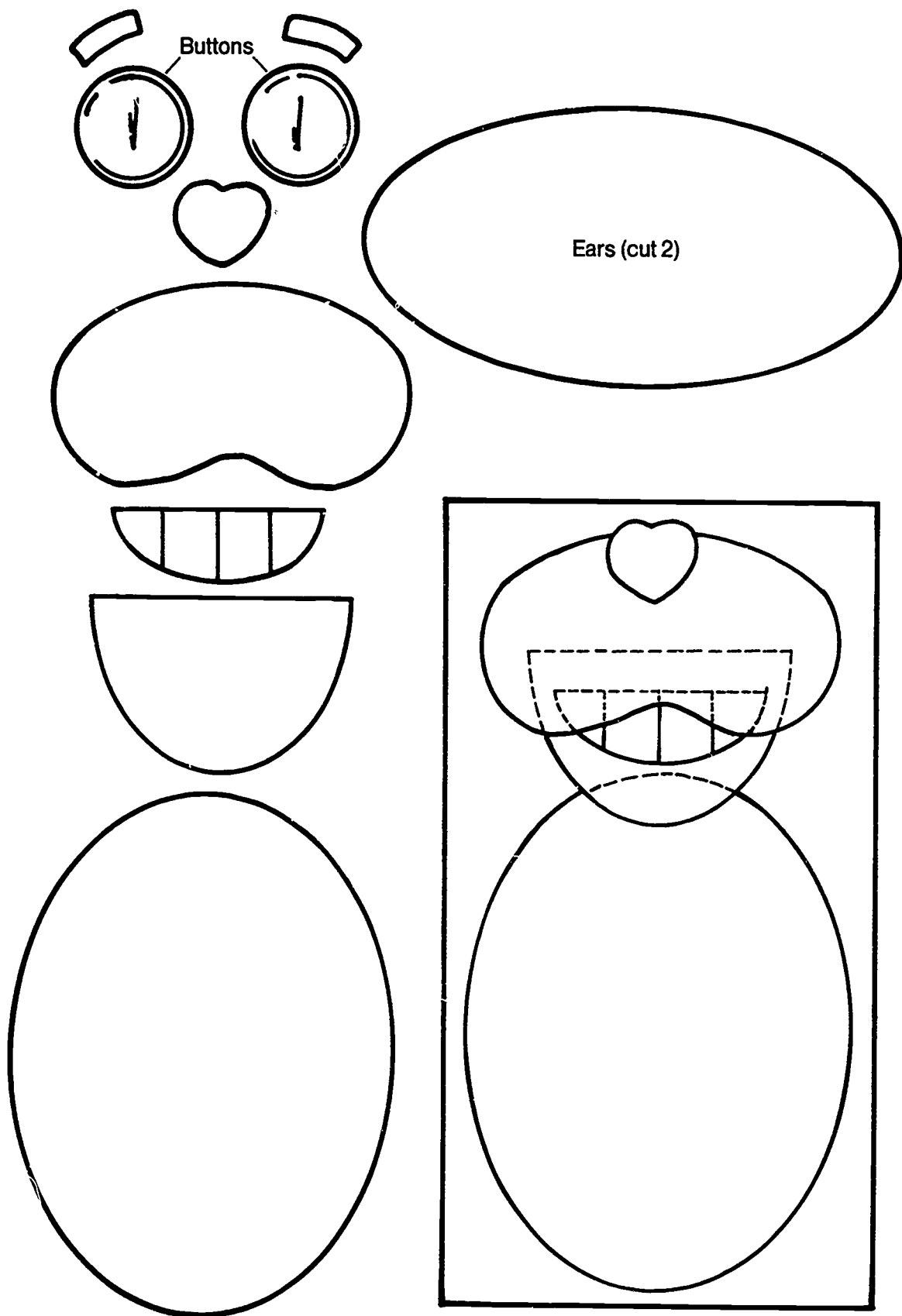

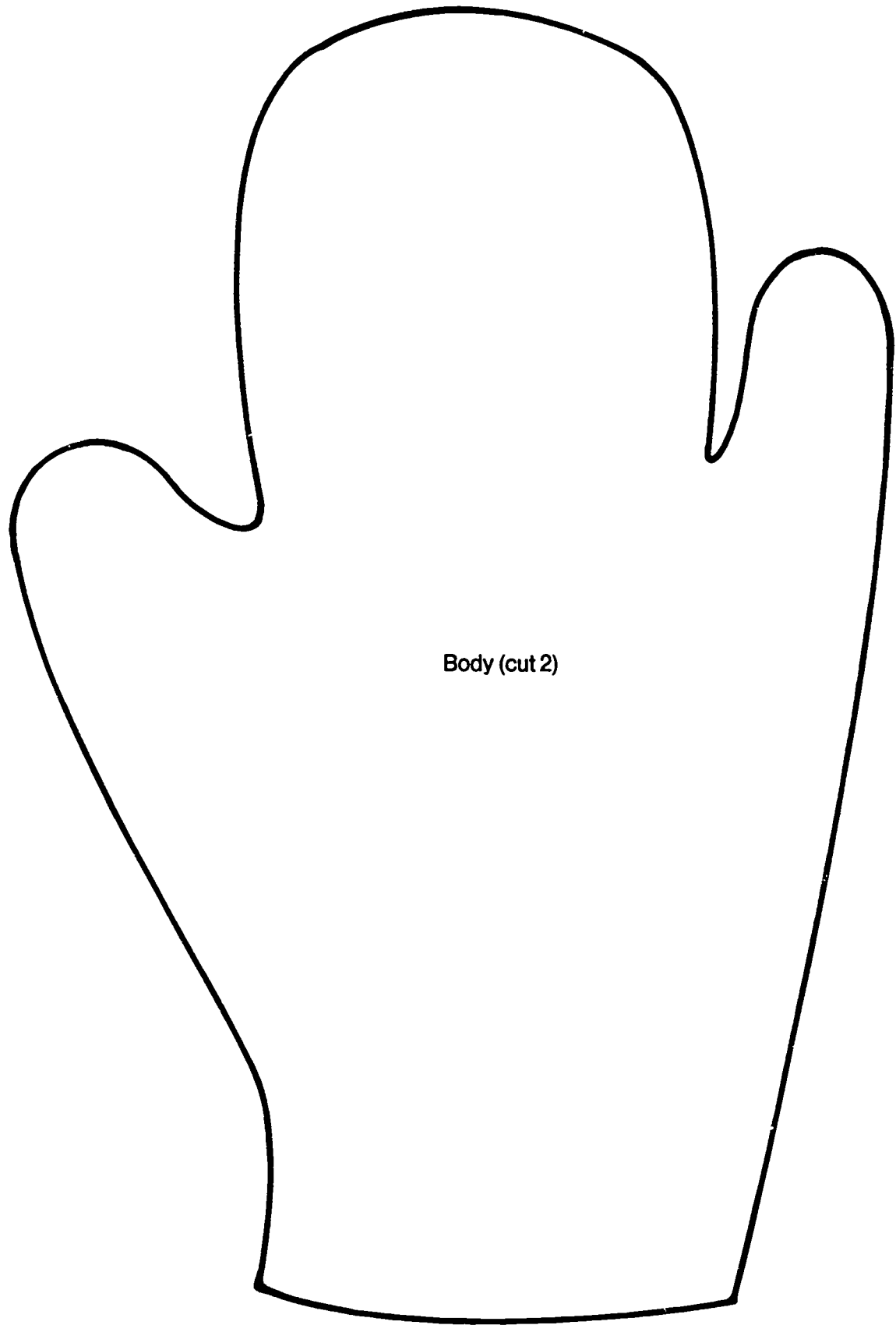

Body (cut 2)



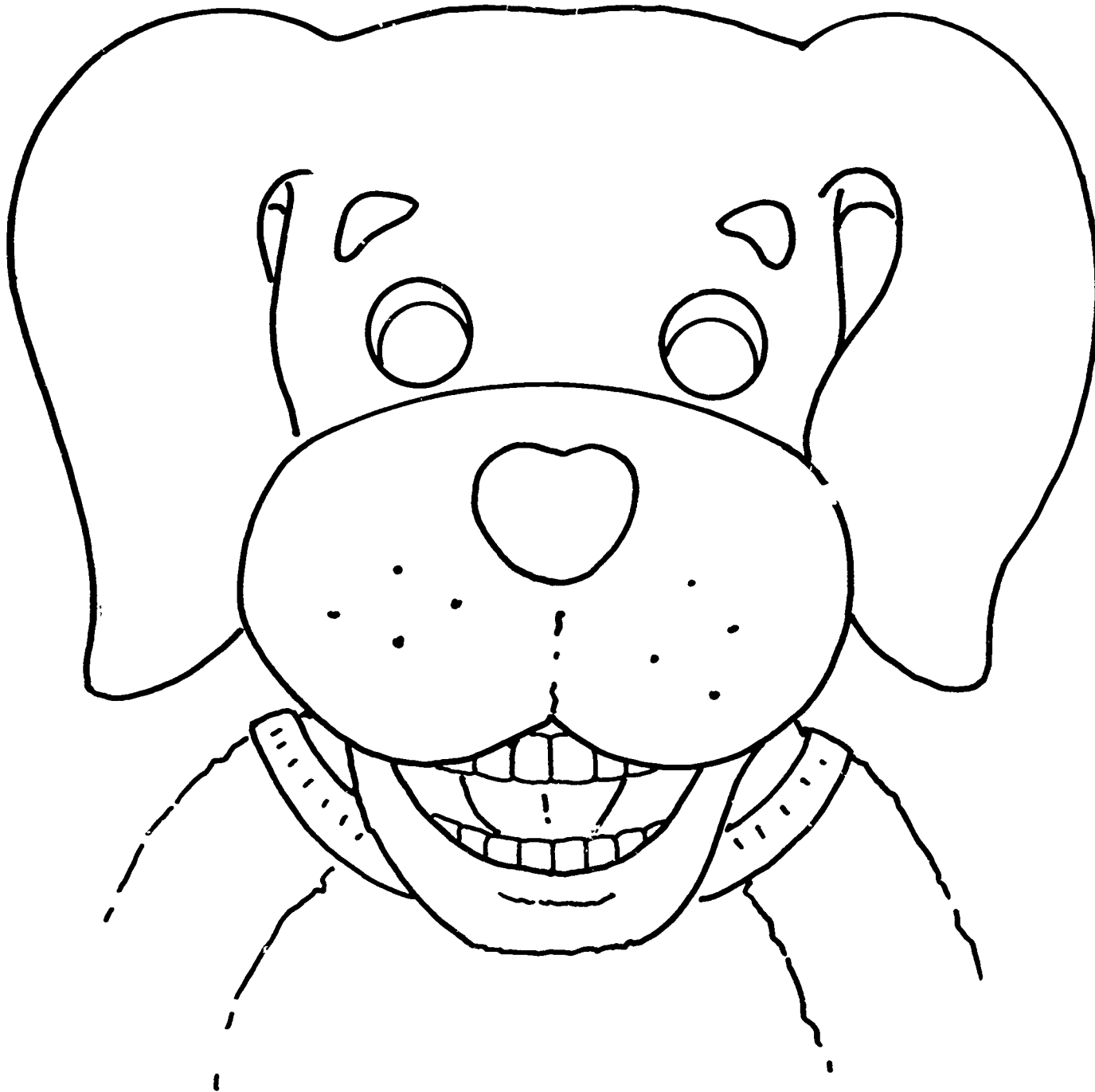

Smiley Face

**LESSON:**

**VISITING THE DENTIST**

**Purpose:**

To familiarize children with the dental office setting and the procedures followed during a dental visit.

**Materials Needed:**

White shirt  
Chair  
Flashlight  
Napkins  
Non-breakable mirror  
Model of teeth (optional)  
Large toothbrush (optional)  
Activity Pages, "Community Helper  
Flannel Board Pictures"  
Crayons  
Paper  
Activity Pages, "A Visit to  
the Dentist"  
Parent Letter, "Visiting the  
Dentist"  
Attachment to Parent Letter,  
"Your Child's First Visit to the  
Dentist"

**Background  
Information  
for the Teacher:**

For good dental health, everyone should see a dentist regularly. During these check-ups, the mouth will be examined, the teeth cleaned, and any dental disease treated.

Dentists have many years of special training in the prevention and treatment of dental disease. A dental hygienist may work with the dentist. The hygienist may clean teeth, show people how to brush and floss, apply fluoride to teeth, and take X-rays. Another member of the dental staff is the dental assistant, who aids the dentist in many ways and who helps keep office records.

Among the equipment and instruments used by a dentist are:

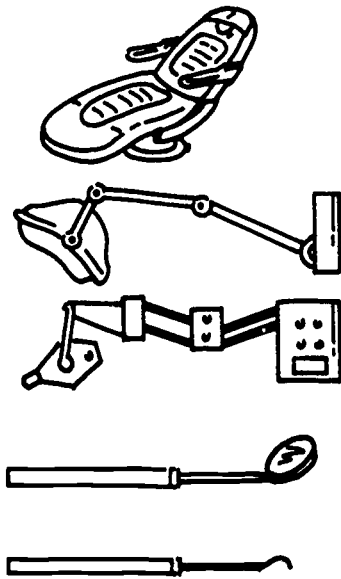

- \* the dental chair, which can be raised and tilted so that the dentist can work easily and the patient can rest comfortably;
- \* the dental light, which can be focused to show all parts of the mouth;
- \* the X-ray machine, which takes pictures of the teeth and bones;
- \* the dental mirror, which is used to see the teeth in the back of the mouth;
- \* and the explorer, which helps the dentist find decay.

Many of your students will be visiting the dentist at some time during the school year. A visit to the dental office can be a pleasant experience. Discuss the appointment with the children. Talk about it in a positive way and in a matter-of-fact manner. Children usually accept the new adventure if they know what to expect and understand the reason for it.

**Starting the Lesson:**

To prepare for this lesson, make flannel board or velcro board pictures using Activity Pages, "Community Helper Flannel Pictures." You may color each picture and put pieces of velcro or felt on the back of it so it will adhere to your velcro or felt board. To make a sturdier picture, you may want to glue the picture to heavier board such as tagboard or poster board.

To begin the lesson, explain to children that there are many people who help us with many things. Display the picture of the bus and bus driver. Tell

children that the bus driver helps by taking children to school. Next, display the picture of a letter carrier. Ask children to describe how the letter carrier helps us. (He or she brings letters and packages.) Display the picture of the truck driver and ask children to describe ways truck drivers are helpful.

Ask the children to name other people who are "helpers."

After the children have had a chance to name several other helpers, ask them if anyone knows who it is that helps them take care of their teeth. After they have identified the dentist or going to the dentist's office, tell them that you have a story to share with them about what happens when visiting the dentist. At this time read the story "A Visit to the Dentist" that goes along with the story pictures found on Activity Pages, "A Visit to the Dentist."

Before reading the story to your class, make copies of each activity page to hand out to each student. Staple the pages together in the correct order. Have students follow along by looking at their copy of the appropriate picture as you read the story. After you have finished the story, go back and ask questions about the pictures. For example:

Page 1. "Can you point to the bus?"

Page 2. "How many children are on the bus?"

Page 3. "Where are the books and magazines?"

Page 4. "Can you point to the dental hygienist?"

Page 5. "Where is the dentist?"  
"What is the dentist's name?"

Other questions you may want to ask after you read the story are:

"What part of the story did you like best?"

"What do you think you would like to do most when you go to see your dentist?"

"Which piece of equipment did you like most?"

"Have you ever seen any of the equipment that is shown in this picture?"

You may want to give the children an opportunity to color these pages and/or to create a cover for their book.

Note: If resources are not available to make enough copies for each student, you may want to color each page and display it while you are reading the story to the class as a group.

Head Start Program Story - "A Visit to the Dentist"

Characters:

Miguel  
Luyen  
Dawn  
Althea  
Bobby  
Mrs. Jackson  
Dr. Lee  
Miss Phillips

Page #1

All the children were excited. Today they were going to meet a new friend. At exactly nine

o'clock, a big yellow bus parked outside the classroom.

Bobby was the first to climb in. "Oh, boy," said Bobby, "this bus is as big as the one my dad drives!"

Sure enough, the bus could fit all the children in the class. And it even had room for more.

Page #2

"Will the dentist's office be this big?" asked Althea.

"Almost as big," answered Mrs. Jackson. "But it's filled with many interesting things, things you can't find on a bus."

The children's eyes sparkled. They could hardly wait to see all the new things the dentist would show them.

Page #3

Soon they were at the dentist's office. Mrs. Jackson opened the door, and the children followed her inside. They entered a small room. It was quiet and filled with all sorts of things. There were plants and pictures, big stuffed chairs, and even some books and magazines.

"Look here," squealed Dawn. She pointed at a nearby table. "There are plenty of storybooks I can look at!"

Miguel, also delighted, found a children's magazine. He picked it up eagerly and showed it to everyone. "My favorite magazine!" Miguel exclaimed.

Page #4

At that moment, a friendly looking woman stepped into the room. "There's Miss Phillips," said Mrs. Jackson. "She's the dental hygienist. She helps the dentist keep your teeth clean and healthy."

"Hello, everyone," Miss Phillips said with a smile. "I'm very happy to meet you."

"Is this where the dentist works?" asked Bobby.

"Well, he doesn't work right in this room," she answered. "This is called the waiting room. You can wait here until it's your turn to see the dentist."

Page #5

The children were so busy listening to Miss Phillips that they didn't see Dr. Lee come into the room. "Hi, boys and girls," he said with a grin.

"Oh," they murmured in surprise.

"You must be Dr. Lee," shouted Althea. "You're dressed just like the dentist in my picture books!"

Dr. Lee was pleased that the children recognized him. "Let me show you some other things you may have seen in pictures," he said.

Page #6

In the next room were many things. Some were small and shiny. Others were very big and were stuck to the floor or wall. Some even made noises or could be moved.

There was a sink for the dentist to wash his hands. A mirror hung on the wall over the sink. And there were lots of drawers to hold Dr. Lee's tools.

Page #7

"What's that chair doing in the middle of the room?" asked Dawn.

Miss Phillips replied, "You lie back in the chair while the dentist looks inside your mouth. It

can tilt backward. It also goes up and down."

"Can I try it?" Luyen asked excitedly.

"Sure you can," said Miss Phillips. "You can each try it, one at a time, when Dr. Lee looks at your teeth."

Page #8

"Why is that big light hanging over the chair?" asked Althea.

"It shines into your mouth so I can see all your teeth," answered Dr. Lee. Then he picked up a gleaming mirror to show the children. "I can also use this tiny round mirror to see the backs of your teeth." It sure was tiny, but it had a long, shiny handle.

Page #9

Next to the chair was a silver tray. It had all sorts of tools on it. There was an explorer, a pointy silver stick to help the dentist check each tooth. There was a jar of a special gel with fluoride in it. Fluoride helps make teeth strong. And there was a special minty toothpaste in a small bowl.

Page #10

"Whrrr, whrrr, whrrr..."

"What's that sound?" asked Miguel, startled.

"Oh, it's just my special toothbrush," Dr. Lee replied. "It has a little rubber cleaner that spins round and round to clean and polish your teeth. Do you hear any other sounds in the office?"

Page #11

The children listened very carefully. They heard something that Miss Phillips was holding make a slurping, sucking sound.



"That sounds like someone drinking out of a straw," said Bobby.

"You're right, Bobby," Miss Phillips answered. "But this is called a suction. It sucks up some of the wetness in your mouth so the dentist can get a good look at your teeth."

Page #12

Luyen pointed to a long machine on the wall. "That machine must make lots of noise. It's awfully big!"

"It is big," said Miss Phillips, "but it makes only a soft, short buzz. It's called an X-ray machine. It takes pictures of the inside of your teeth so we can be sure they're strong and healthy."

Page #13

"Why are water and hoses over there?" asked Dawn, pointing. "Are they for watering the plants in the other room?"

"No, no," chuckled Dr. Lee. "The hose lets me squirt water on your teeth, to clean them. It also sprays air to dry your teeth." And saying this, Dr. Lee sprayed a little bit of air on Dawn's hand. It was warm and gentle, like air let out of a balloon.

Soon all the children wanted Dr. Lee to squirt their mouths with water and clean their teeth with his special toothbrush. They were happy to have this nice, caring man as their friend.

Page #14

Dr. Lee took some toothbrushes out of a drawer. There was a red brush, a blue one, and a green brush. There was a white brush and a yellow one. So many colors to see! And Dr. Lee gave one toothbrush to each child. Do you know what color Miguel, Luyen,

Dawn, Bobby, and Althea chose?

Page #15

The children thanked Dr. Lee. They thanked Miss Phillips, too, for showing them so many new things. Now the children could hardly wait to go home to try out their colorful new toothbrushes. They had lots to tell their family about what they had seen.

Classroom  
Activities:

1. Classroom Visitor - Make arrangements for a dentist or a dental hygienist to visit your class. Ask them to bring examples of things that are used in the dentist's office or, if possible, pictures or charts. Have them explain what happens during a visit to the dentist.
2. Field Trip - Arrange to take the class to visit a dentist's office or dental clinic in your community. This will help reinforce the concept of community helpers.
3. Language Arts Activity - Have the children assist you in composing a thank you note to the dentist whose office you visited or to the professional who visited your class.
4. Art Activity - Ask the children to draw a picture of something that they enjoyed during the trip to the dentist's office. Their pictures may be included with the letter to be sent to the dentist or dental professional.
5. Role playing - Set up a dentist's office. This role playing area should have a white shirt, a chair, a flashlight, a napkin that can be hung around a child's neck, a non-breakable mirror and, if available, a large model of teeth and a toothbrush. (Be sure

to instruct children that they should not put their hands in one another's mouths. They may practice brushing the model of teeth, or they may show one another how to brush, using the model.)

6. Counting - Children should be encouraged to count the teeth of the model. (You may be able to obtain an old study cast of teeth from a dentist in your area if you do not have a model of teeth.)

Lesson Review,  
Puppet Story:



Hello, boys and girls! Well, I'm back again, just as I promised. Today we're talking about some of the people who help us with many things. Can you tell me how the bus driver helps us? Another "helper" is the letter carrier. How does the letter carrier help us? And let's not forget the truck driver. Can you name some of the good things truck drivers bring us? Can anyone think of other people who are helpers? Very good!

Did you know that there also are people who help us take care of our teeth? They are dental helpers. These are the people who help keep our teeth clean and strong. Can you name the dental helpers? Good. They can also fix our teeth good as new when they need fixing.

Do you remember all the neat looking things in the dental office? Things like a chair for you to sit in that goes up and down? Or the little thing the dental helper uses to shine up your teeth that goes whrrr whrrr? What things do you like best in the dental office? That's terrific! All these neat things are used by those nice

dental helpers to keep our teeth clean and strong and looking great. Well, I think you really learned a lot about the many kinds of helpers and all the things they can do to help us. I have to go now, but I'll be back soon and we'll talk some more about our teeth. Bye, boys and girls.



Parent Letter: "Visiting the Dentist"

Dear Head Start Parent:

Now that your child is Head Start age, he or she will be seeing a dentist. Dental examinations are an important part of the Head Start Program. To help prepare your child for this dental visit, your child is learning that the dentist and other members of the dental team are friendly people who take care of our teeth and keep them healthy.

During your child's first dental visit, the dentist will examine your child's teeth for tooth decay or other problems. The dentist may also show you how to care for your child's teeth. A trip to the dentist can be a pleasant adventure, and you can help make it so with a positive attitude. Attached is a page that will help you handle your child's first visit to the dentist and help you answer questions your child may have.

A dental examination should take place as soon as possible. Regular dental visits are important and can help save your child's teeth by preventing dental problems. Your dentist will tell you how often your child needs a dental visit. With your help, dental visits will always be a pleasant experience for your child.

Sincerely,

## YOUR CHILD'S FIRST VISIT TO THE DENTIST

(Suggestions for answering children's questions)

A visit to the dental office can be a pleasant experience. If your child wants to discuss the appointment, talk about it in a positive and matter-of-fact manner. Children usually accept a new adventure if they know what to expect and understand the reason for it. The following are some questions children commonly ask. The answers provided will help prepare you for these questions:

Question:

"Why do I have to go to the dentist?"

Answer:

"The dentist helps you take care of your teeth. He/she will show you how to brush your teeth, and he/she knows how to find the teeth that need his/her help."

Question:

"What is the dentist going to do?"

Answer:

"The dentist will look in your mouth, count how many teeth you have, and see if any of your teeth need special care. The dentist may clean your teeth with a little soft sponge that goes round and round. He may put a special gel on your teeth to make them stronger. The dentist may also put a special plastic on the top of your back teeth to help keep out the germs."

Question:

"Is it going to hurt?"

Answer:

"No, visiting the dentist usually doesn't hurt. The dentist does everything possible to make your teeth feel good. If you feel pain or it hurts, tell the dentist and he or she will try to make it feel better."

### SOME DO'S

1. Be honest with your child about what will happen.  
Trust is an important feeling between any two people

and especially between children, their parents, and their teachers. By answering your child's questions truthfully, you will establish a feeling of trust. If you don't know the answer to your child's question, tell your child that you do not know the answer but that the dentist will be happy to answer any question during the first dental visit.

2. Use a visit to the dentist as an adventure not as a threat.
3. Encourage friends and family to be positive about dental visits in front of your child and not to discuss unpleasant dental experiences.

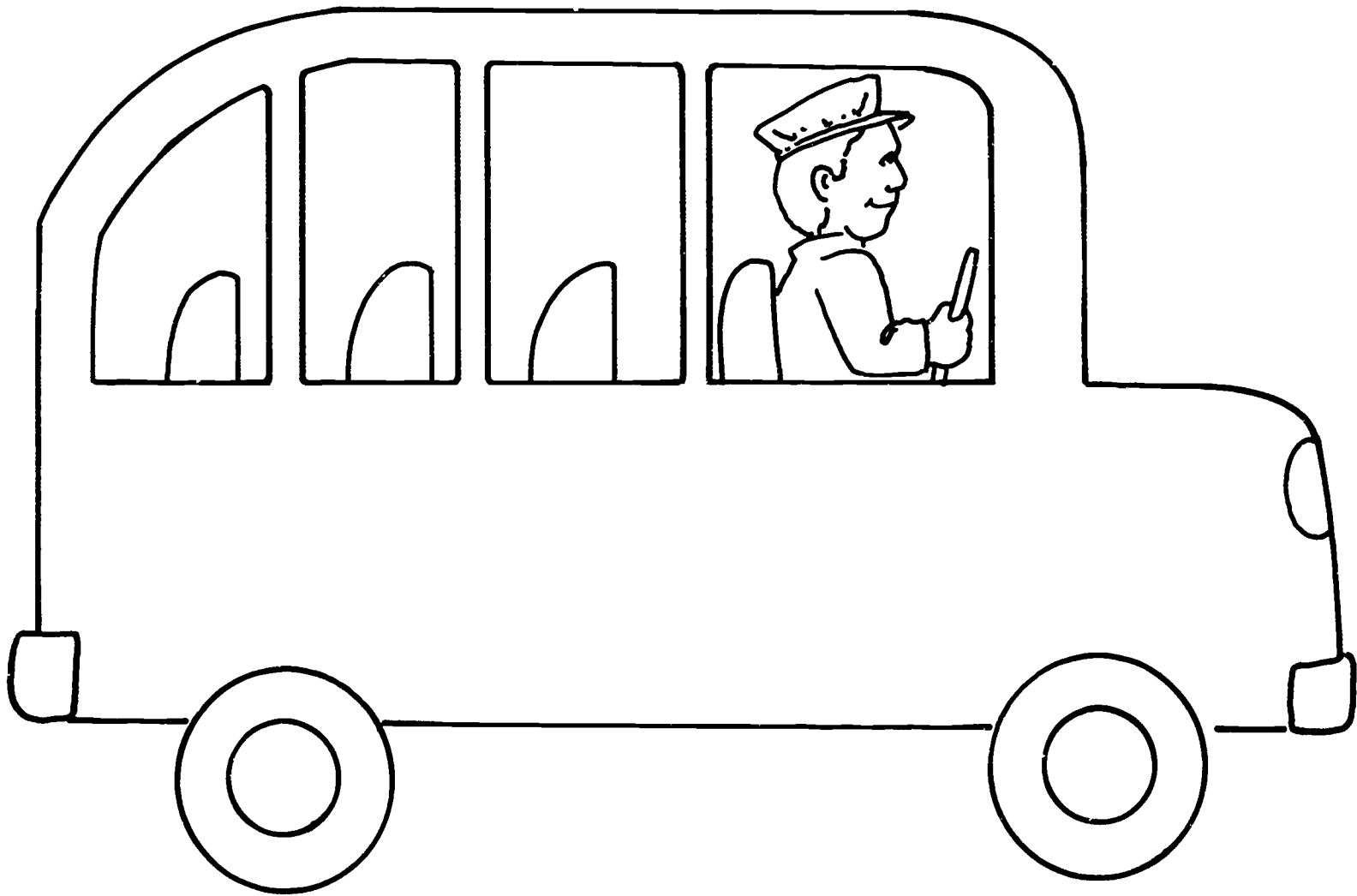

33

34





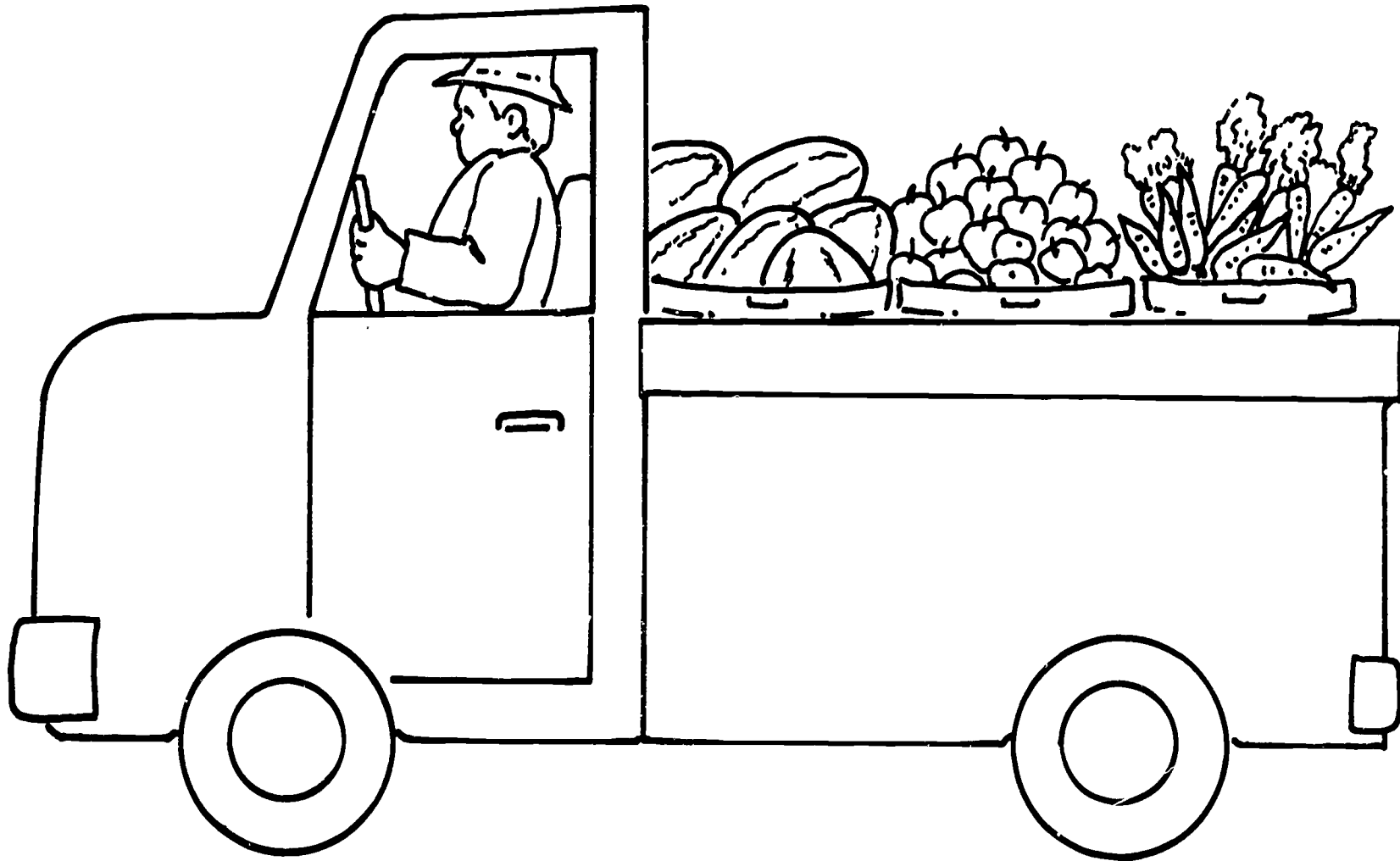

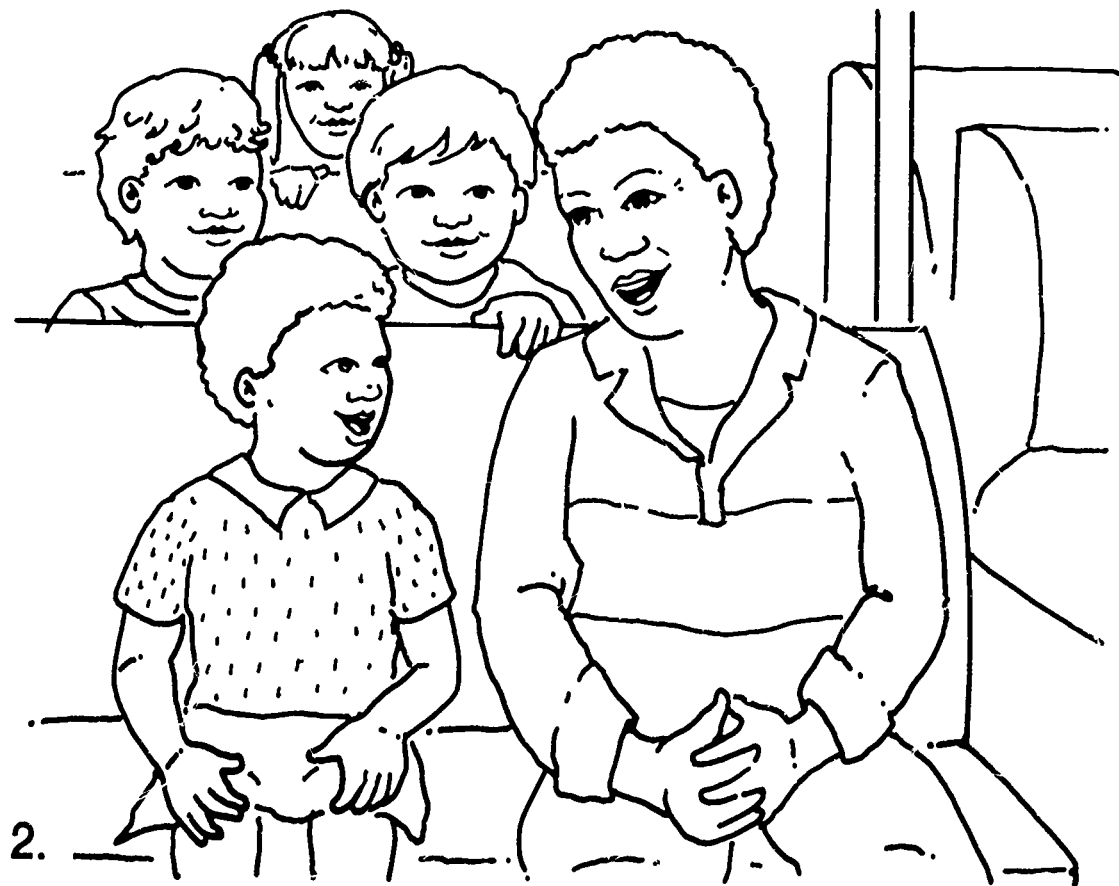
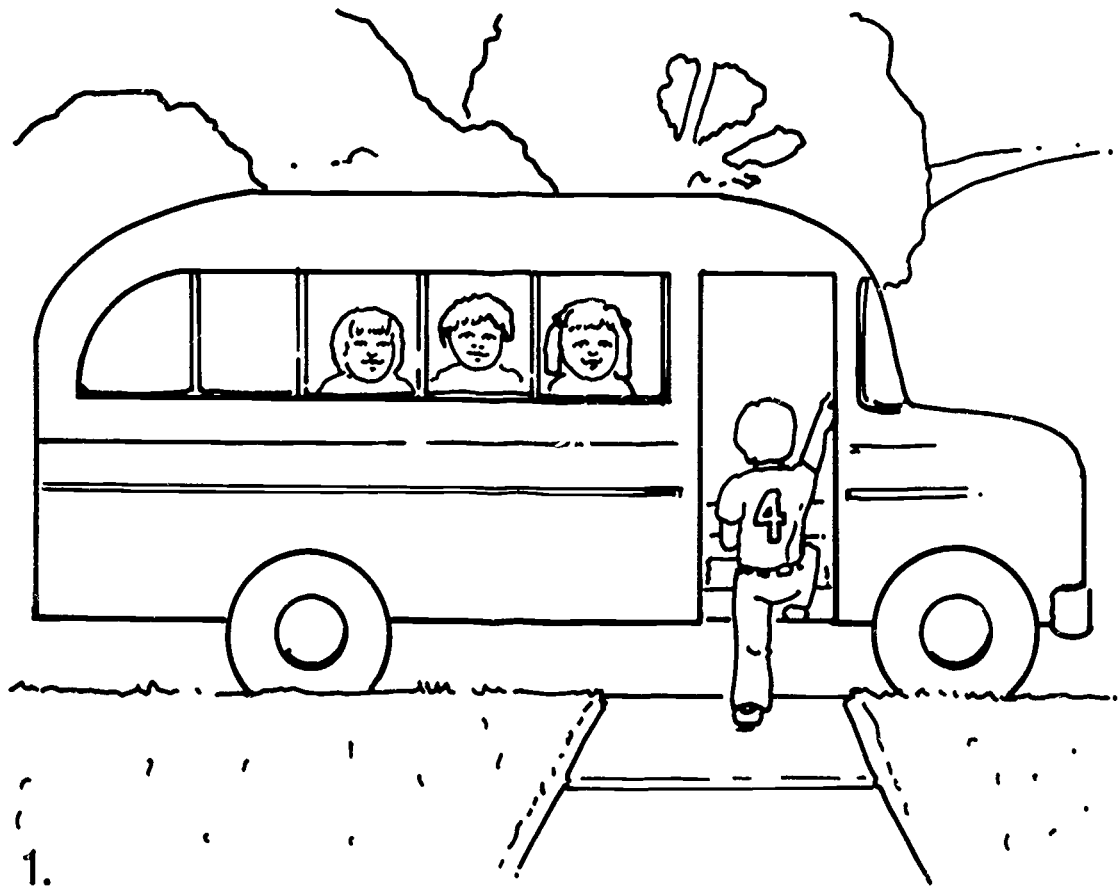

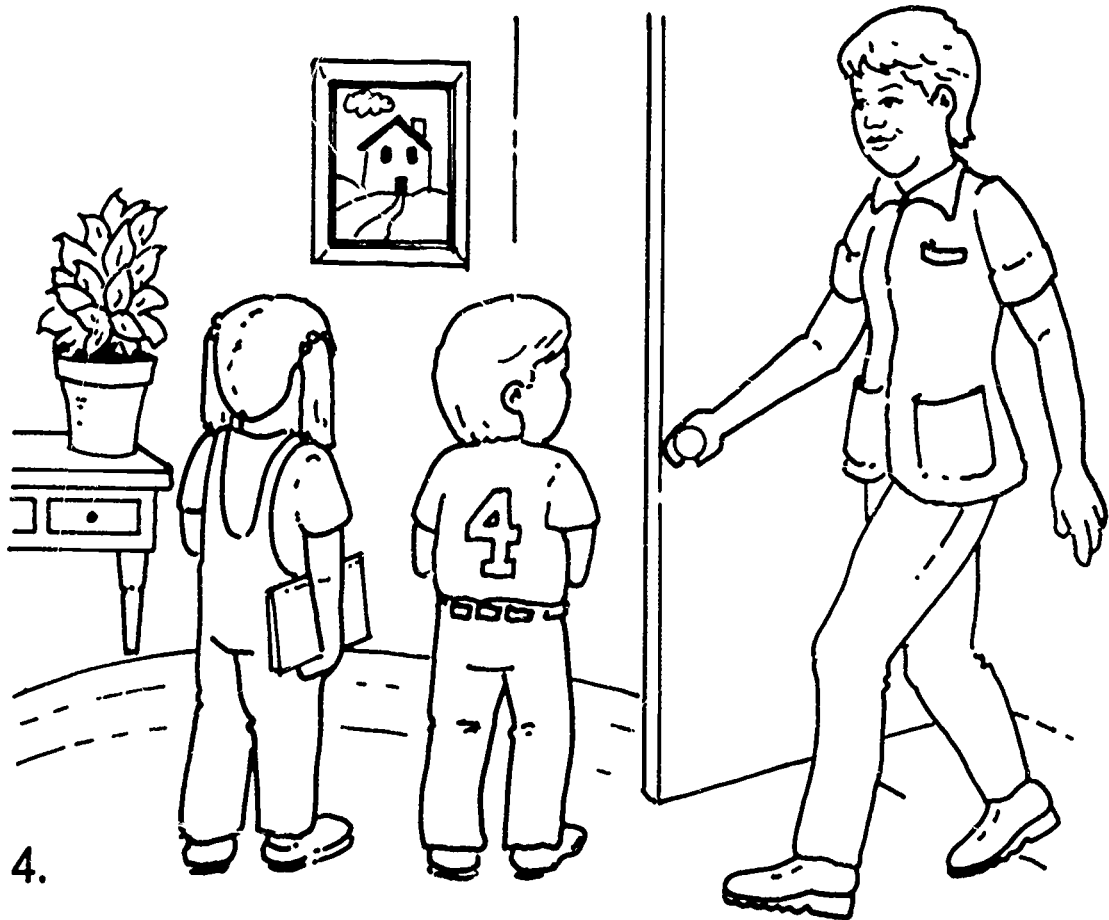
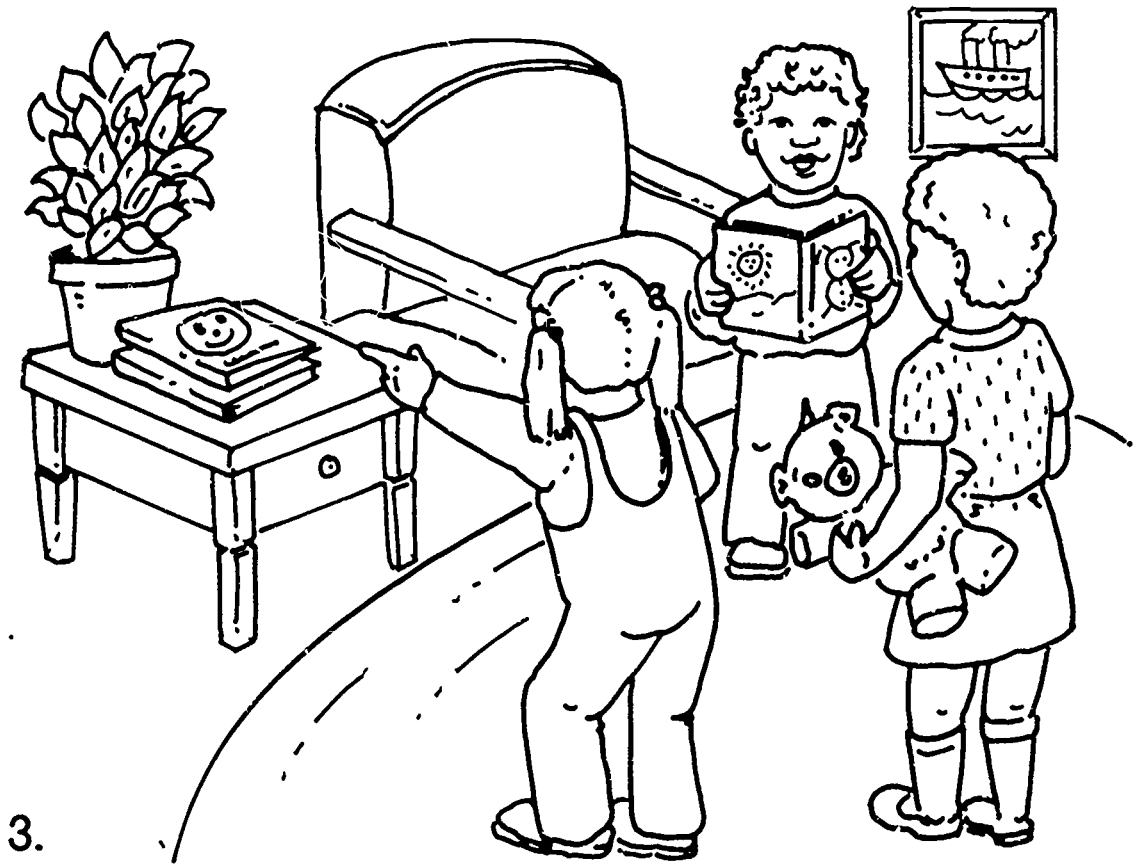

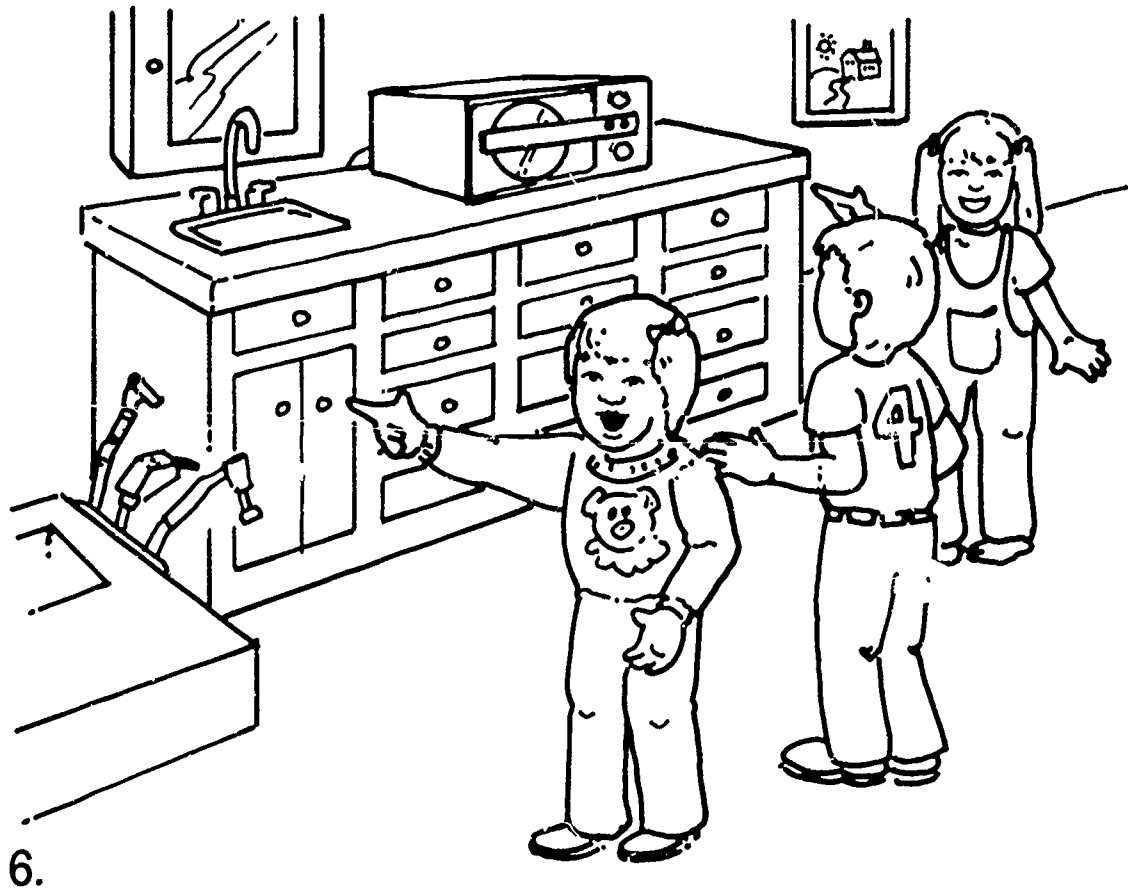

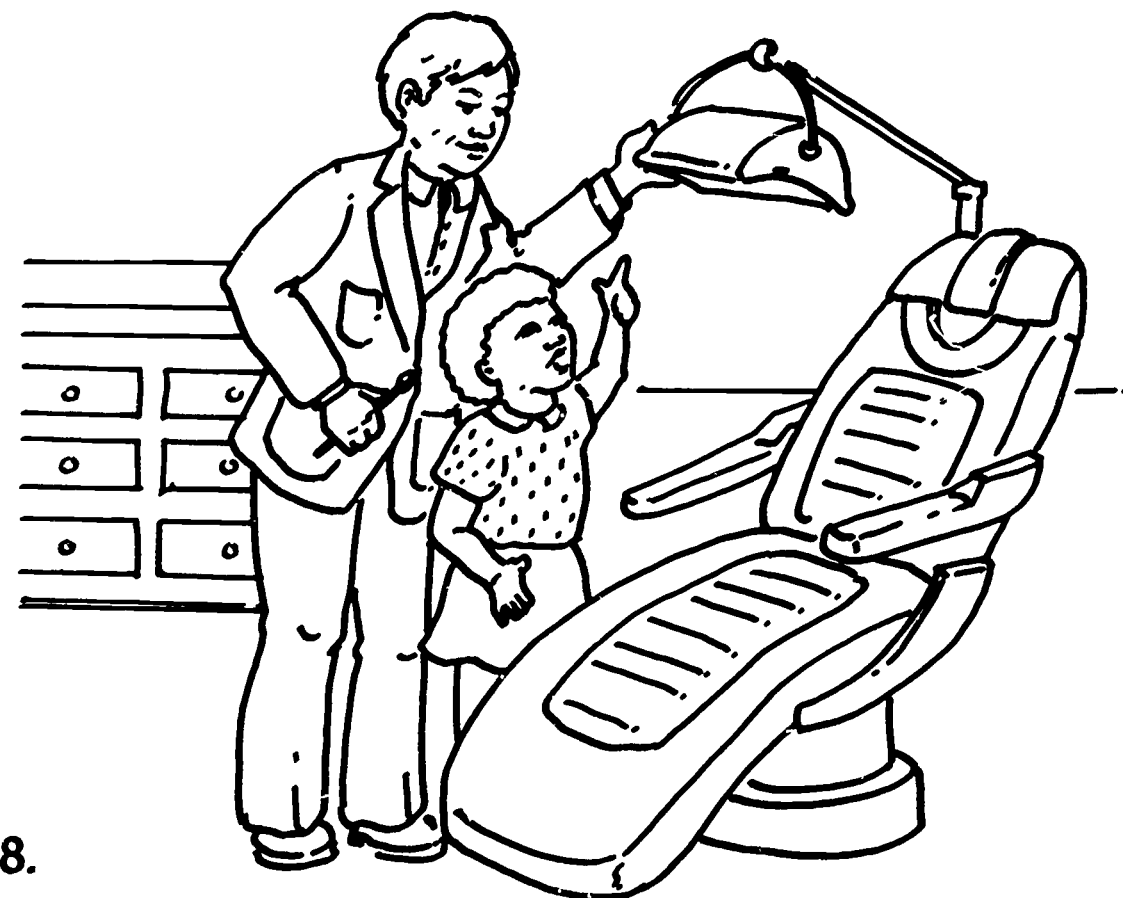

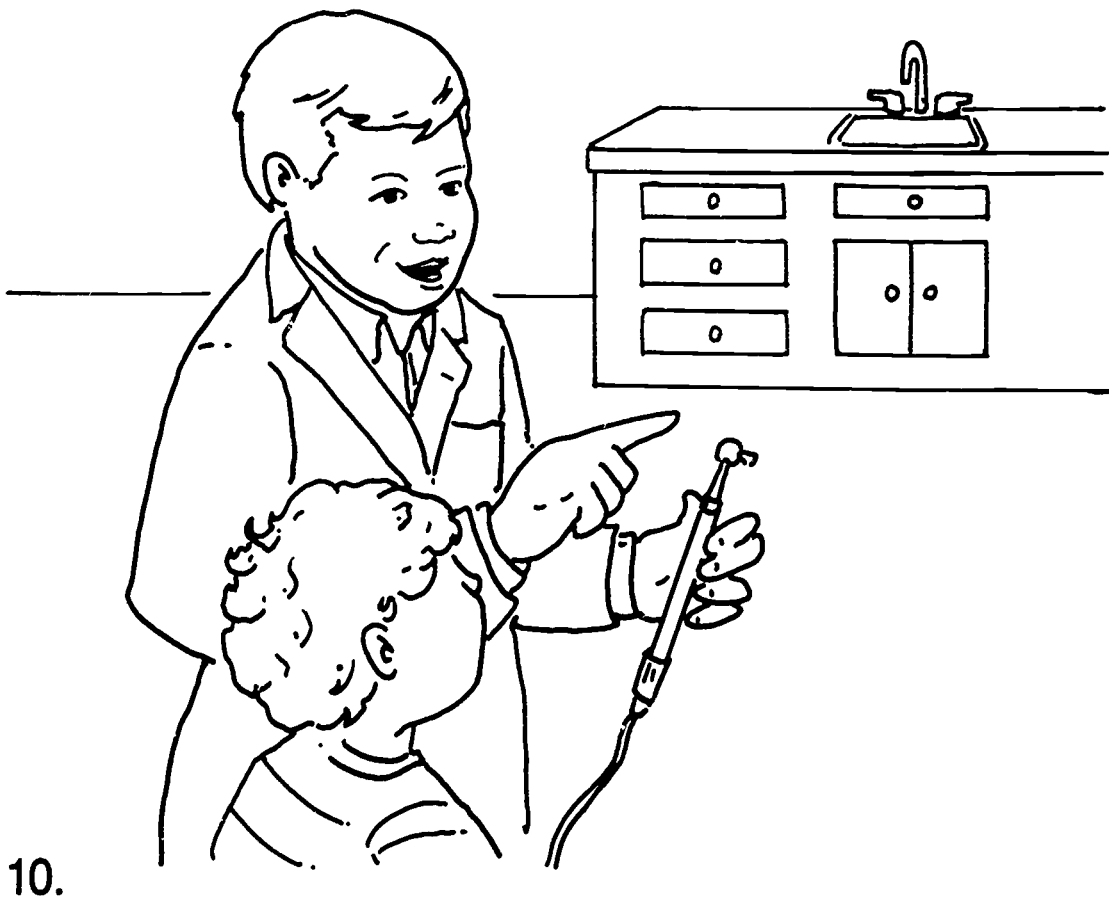
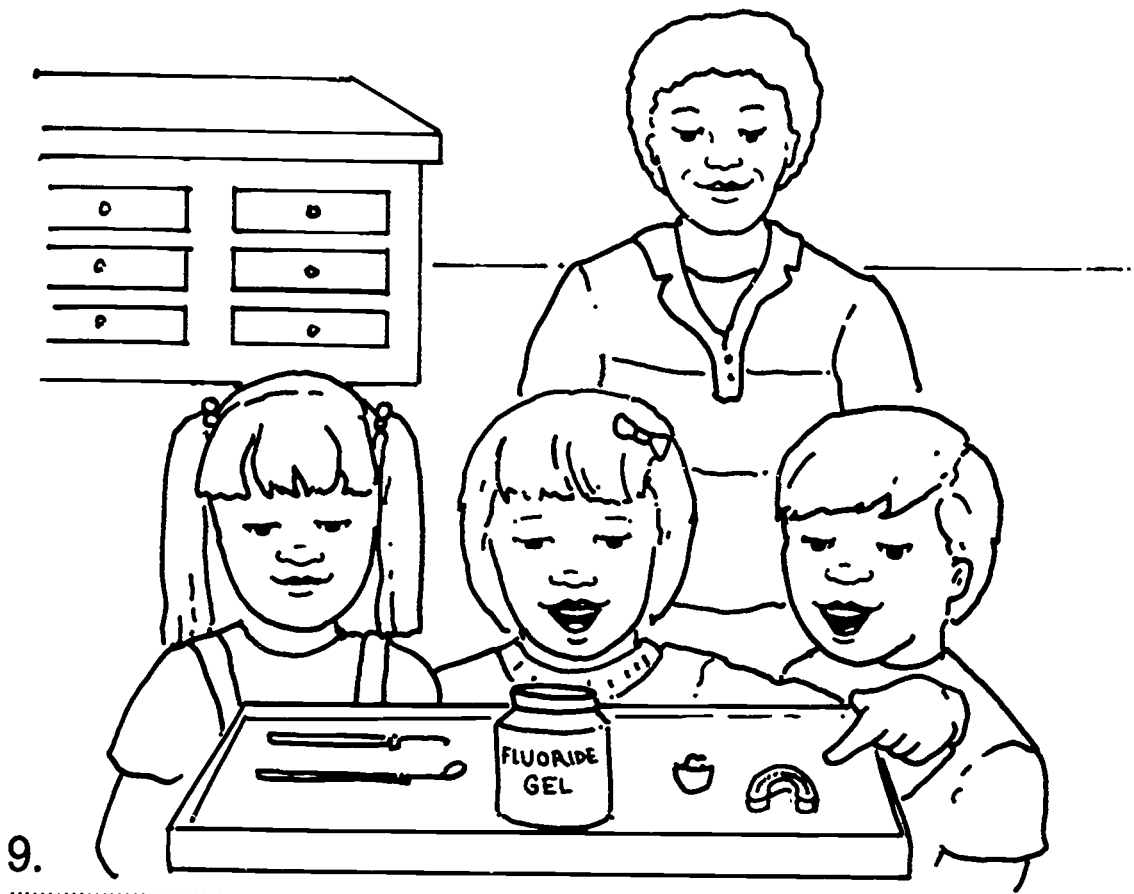

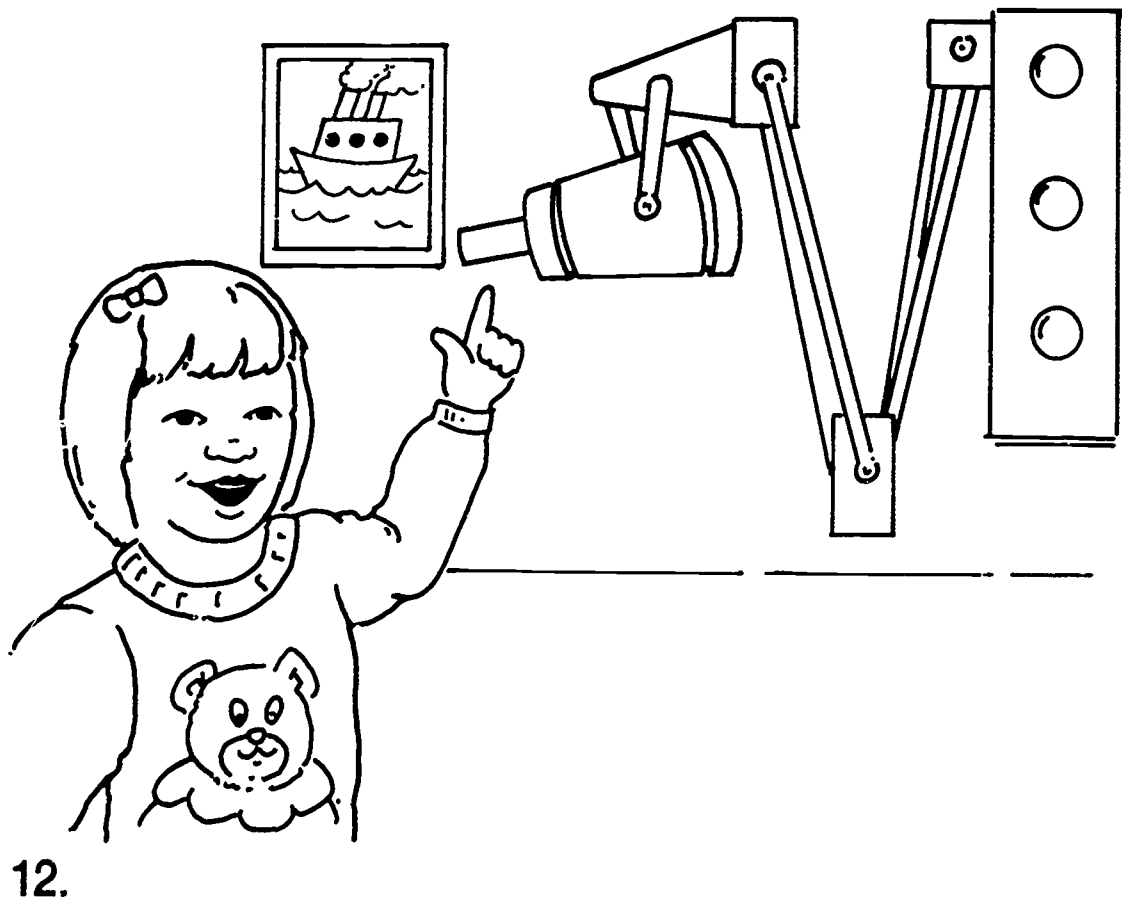





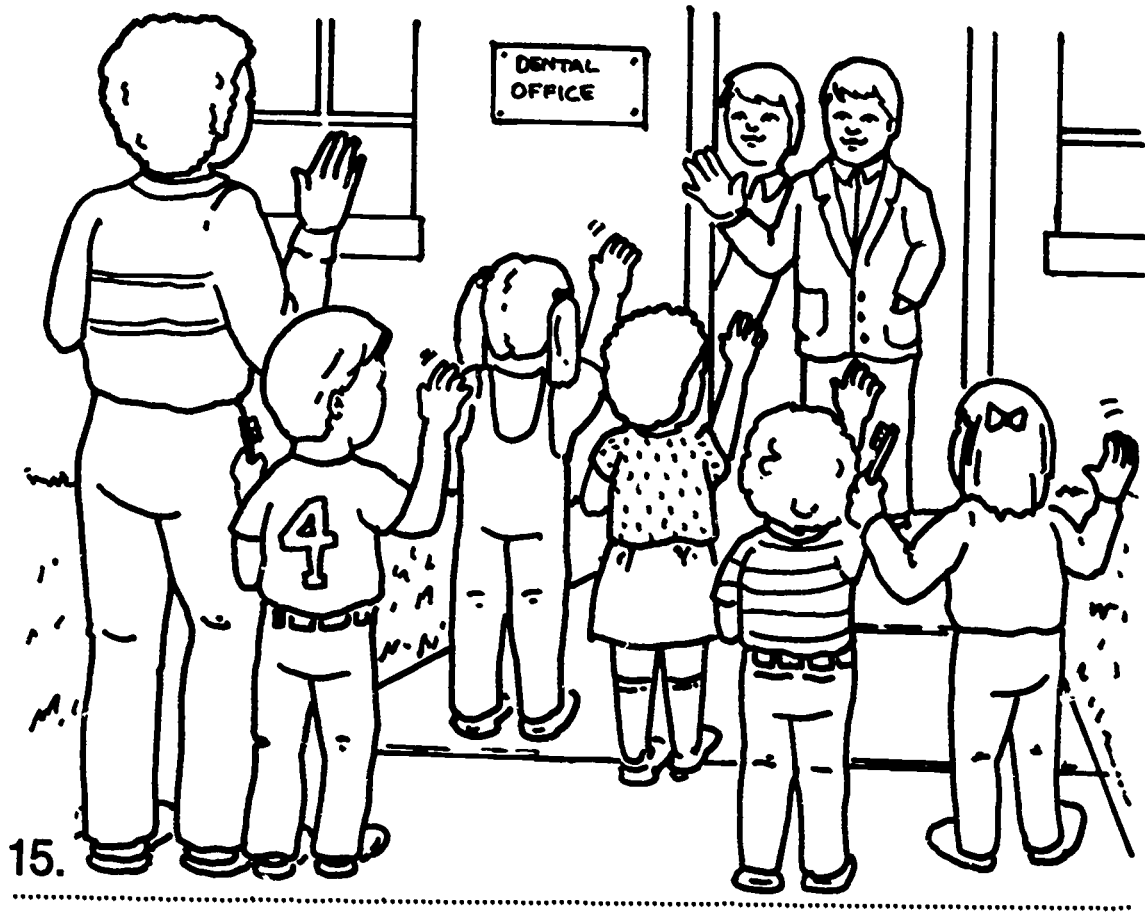

A Visit to the Dentist

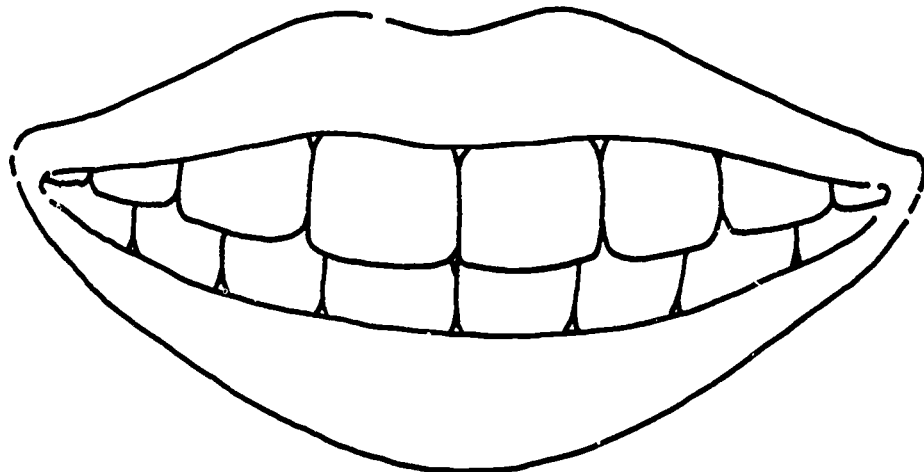

**LESSON:**

**AWARENESS OF THE MOUTH**

**Purpose:**

To create an awareness of the various structures found in the mouth.

**Materials Needed:**

Small unbreakable hand mirrors  
(one per student, if possible)  
Photographs of students (optional)  
Polaroid camera (optional)  
Activity Page, "Face with Missing Part"  
Parent Letter, "Awareness of the Mouth"

**Background Information for the Teacher:**

Children should be made aware of the mouth as an important part of the body. This understanding will help them become interested in giving the mouth the daily care it needs for good health.

Each of the parts in the mouth--the teeth, gums, lips, tongue, cheeks--has its own special purpose. Healthy mouths look and feel different from mouths that are not in good health. Healthy teeth are a shade of white, shiny, and strong. Healthy gums are pink or brownish, depending upon race. Healthy tongues are pink or red.

**Starting the Lesson:**

Begin this lesson by instructing children to wash their hands with soap and water. If available, distribute nonbreakable mirrors to each child.

- A. Ask the children the following questions:

"Where are your eyes?" (Have children point to their eyes.)

"Where are your ears?" (Have children point to their ears.)

"Where is your nose?" (Have children point to their nose.)

"Where is your mouth?" (Have children point to their mouth.)

"Where is your tongue?" (Have children point to their tongue.)

"What do your eyes do?"

"What do you like to see when you go outside?"

"What do your ears do?"

"What do you like to hear when you are at school?"

"What does your nose do?"

"What do you like to smell when you are at home?"

"What does your mouth do?" (Try to elicit from children "eat," "talk," "chew," and "smile.")

"What foods do you like to eat?"

"What do you like to talk about?"

"What makes you smile?"

- B. Emphasize to the children that the mouth helps us do many things. Instruct the children to look inside their mouth. If possible, distribute mirrors for the children to use. If mirrors are not available, have the children look in each others' mouth.

Ask the children what they see inside their mouth (encourage responses such as "white teeth," "pink or brown gums," "pink or red tongue").

- C. Have the children feel their teeth and lips with their finger. Ask the children questions such as:

"What do you see in the mirror when you smile?"

"What do your lips feel like?"

"What do your teeth feel like?"

"Are your teeth wet or are they dry?"

"Are parts of your teeth smooth?"

"Are parts of your teeth rough or bumpy?"

"Are your teeth hard or are they soft?"

"Are there any spaces between your teeth?"

- D. Ask the children the following:

"Where is the top of your mouth?" "Can you point to it?"

"Point to the bottom of your mouth." "What's at the bottom of your mouth?" (tongue)

"Point to the sides of your mouth." "What's at the side of your mouth?" (cheeks)

Classroom  
Activities:

1. Art Activity - Distribute Activity Page, "Face with Missing Part" to each student. Discuss what is shown in the picture. Ask the students what is missing. Instruct the students to complete the picture by adding their smile and any other physical characteristics they wish to create.

If available, have children glue beans, macaroni or yarn to complete the picture.

You may also have children turn the sheet over and draw a picture of themselves or something that makes them smile.

2. Language Arts Activity - Give individual children an opportunity to show their completed picture to the class and explain why the face is smiling. Do not insist that every child participate, only those who wish to do so.
3. Music Activity - Teach children the following song: "Smiles We See," sung to the tune of "Row, Row, Row Your Boat."

Smiles, smiles, smiles we see

Smiles for you and me

My teeth are clean

My teeth are white

My face is very bright.

4. Art Activity for Bulletin Board - Take pictures of every child in the class or have children bring in a photograph showing themselves smiling. Display the photographs on the bulletin board. If photographs are not available, you may display each child's completed Activity Page, "Face with Missing Part."

Encourage children to suggest a title for the bulletin board. Based on their responses, select a title, cut out letters, and post on the bulletin board. The completed bulletin board may be used to practice letter recognition by having children identify individual letters in the title.

Lesson Review,  
Puppet Story:



Hi, boys and girls. It's nice to see you again. Wasn't it fun learning all about your face? Let's see if you remember all the different parts. Can you all point to your eyes? Terrific! And who would like to tell me what your eyes do? Very good! Now show me your ears. That's right! Who wants to tell me what your ears do? Excellent! Now what's that thing in the middle of your face that sometimes goes sniff, sniff? Right, it's your nose. Can all of you put a finger on your nose? That's great! And who can tell me what your nose does? Terrific!

There's another part of your face we haven't talked about. You use it to talk and to do many other things. Who can tell me what it is called? That's right! Can you point to your mouth? Very good! What are some of the things you can do with your mouth? (talk, eat, chew, smile) Let's see everyone's big smile! Now let's hold up our mirrors and look at what's inside the mouth. Would someone like to tell me one of the things you see inside your mouth? (teeth, tongue, lips, gums, cheeks) Good! Can someone else name something that's in your mouth? Very good! Now look at your tongue. What color is it? Can you wiggle your tongue? Terrific! Use your tongue to feel all the parts of your teeth. How do they feel? Wow! You've learned a lot about the different parts of your face and what's inside your mouth. Next time, when I come back, we'll talk some more about some of the parts of the mouth and what they do for us. See you soon! Bye!



Parent Letter: "Awareness of the Mouth"

Dear Head Start Parent:

It is important for children to learn about and take care of their teeth and mouth. Today your child learned about the different parts of the mouth such as the teeth, gums, cheeks, lips, and tongue. We believe our dental health lessons in Head Start will help your child learn about the importance of the mouth and help him or her prevent dental disease.

You may want to have your child tell you about the different parts of the mouth. You might also point to a part in your mouth and ask your child to name that part.

I will send you more information on the dental health program as it continues. If at any time you have any questions, please feel free to call me.

Sincerely,



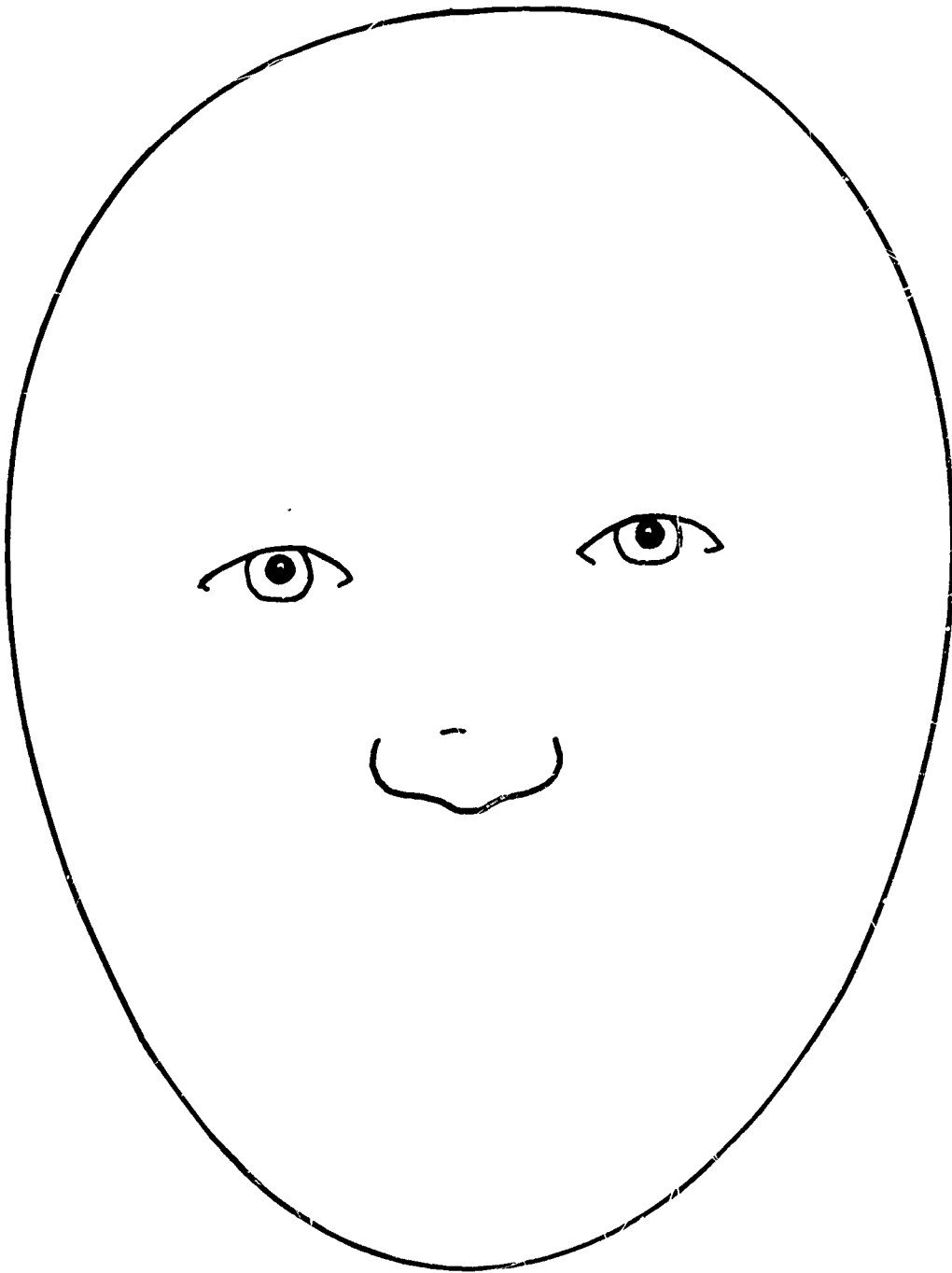

**LESSON:**

**THE IMPORTANT FUNCTIONS OF THE MOUTH**

**Purpose:**

To develop an understanding of the three important functions of the mouth.

**Materials needed:**

Old magazines  
Construction paper (optional)  
Activity Page, "Functions of the Mouth"  
Parent Letter, "The Important Functions of the Mouth"

**Background Information for the Teacher:**

Head Start recognizes that a healthy mouth affects a child's language development, social development, self-esteem, and learning.

Children need to understand that taking care of their mouth is important because they need to use their mouth and teeth in many ways.

Eating. With a healthy mouth and teeth, we can eat a wide variety of foods that are good for us. Healthy, strong teeth help us chew our foods well, which aids in digestion.

Speaking. The teeth and the other parts of our mouth are used to make the proper sounds for many letters of the alphabet. They help us speak clearly.

Appearance. The mouth is used when we smile or use other expressions. The teeth help give shape and form to our face. With a healthy mouth, we look good to ourselves and to others.

- Starting the Lesson:
- I. Begin this lesson by singing the song "Smiles We See" with the children. (See Lesson, "Awareness of the Mouth.")
  - II. Show the children Activity Page, "Functions of the Mouth," or find magazine pictures that show the various functions of the teeth, including someone eating, someone talking, and someone smiling.
    - A. Referring to just the picture showing a person smiling, ask the children the following questions:
      - "What is this person doing with his/her mouth?"
      - "Could you smile if you did not have a mouth?"
      - "What would your smile look like without teeth?"
      - "How would you feel if you couldn't smile?"
      - "How do you feel when you are smiling?"
      - "What do your teeth do for your smile?"
    - B. Next refer to the picture that shows someone talking. Ask the children the following questions:
      - "What is this person doing with his/her mouth?"
      - "What do you see move when people talk?" (Elicit responses that the lips, teeth, and tongue move when people talk.)
      - "Try to talk without moving your mouth." (Have students hold their lips together to see if they can talk.)

"Could you talk without a mouth?"

"What would happen if you could not talk?"

"How would you feel if you could not talk?"

"How would this person feel if he/she could not talk?"

Instruct all children to say the word "Tooth" and to notice the movement of their classmates' lips, teeth, and tongue as they are all saying the word "Tooth." (Note: It is typical for children at this age to pronounce the "th" sound as an "f.") Have children practice saying various words, such as their own name, or words that begin with "D" as in dentist, "L" as in light, and "S" as in sun. If mirrors are available, instruct students to watch their lips, teeth, and tongue move as they say various words.

- C. Show the third picture that illustrates a person eating. Ask the children the following questions:

"What is this person doing with his/her mouth?"

"What moves when you eat food?"

"What part of your mouth do you use when you are eating foods?"

"Could you eat without a mouth?"

"What would happen if you couldn't eat?"

"How would you feel if you couldn't eat?"

"How would the person in the picture feel if he/she couldn't eat?"

"Could you chew food if you didn't have any teeth?"

"What would happen if you couldn't chew big bites of food?"

"How would you feel if you couldn't chew big bites of food?"

Classroom  
Activities:

1. Music Activity - Teach children the following song, "Smile, Talk, Chew," sung to the tune of "Here We Go Round the Mulberry Bush." After the children have learned the song, have them perform a movement or an expression for each verse to imitate "smiling," "talking," and "chewing." Children may also be taught to clap their hands as a rhythm activity during this song.

"Smile, Talk, Chew"

Verse one:

This is the way we use our mouth

Use our mouth

Use our mouth

This is the way we use our mouth

Smile, Smile, Smile

Verse two:

This is the way we use our mouth

Use our mouth

Use our mouth

This is the way we use our mouth

Talk, Talk, Talk

Verse three:

This is the way we use our mouth

Use our mouth

Use our mouth

This is the way we use our mouth

Chew, Chew, Chew

Verse four:

These are the ways we use our  
mouth

Use our mouth

Use our mouth

These are the ways we use our  
mouth

Smile, Talk, Chew

2. Game "Catch a Smile" - Instructions: Have children sit in a circle. The child who is "IT" smiles a big smile (everyone else must be serious). "IT" looks at a certain child, wipes smile off with his/her hand, and throws smile to another child. The child receiving the tossed smile then becomes "IT." The new "IT" repeats this activity. If anyone smiles at "IT" or at the one receiving the smile, he or she is out. The children who are out form a circle outside the ones who are still in the game.
3. Art Activity for Bulletin Board - Give children old magazines. Have them find pictures of people who are eating, talking, or smiling. Allow children to cut or tear the pictures out and glue them to pieces of construction paper. Various colors and shapes of construction paper may be used

to reinforce colors and shapes. Use these pictures for a bulletin board.

Have children create a title or name for the bulletin board.

Children may also use magazine pictures of people eating, talking, or smiling to make a collage on pieces of construction paper.

4. Chewing Activity - Have children wash their hands. Give each child a portion of a carrot and allow him/her to eat it. (You may wish to conduct this activity around snack or meal time using food you have available. If you do not use carrots, select a food that requires biting and chewing.) Have the students point to the teeth they used to bite the carrot. Then have them point to the teeth used to chew the carrot. Reinforce the idea that teeth are used to bite and chew.

Now ask the children the following questions:

"Who has seen a little baby?"

"What foods does a newborn baby eat?" (Encourage responses such as milk, soft foods, strained foods or baby food.)

"Can a little baby eat a carrot?"

"Why can't a baby eat a carrot?"

"What do you have in your mouth that babies don't have in their mouth?"

"Can you eat a carrot?"

Lesson Review,  
Puppet Story:



Hello, everybody! It's great to see all of your smiling faces once again. Today you learned about some of the important things you do with your mouth, like smiling. If you didn't have a mouth, you couldn't smile. Let's see all of you smile. Oh, that's real nice! Seeing your smiles makes me feel like smiling.

We do something else with our mouth and teeth when we eat. Can anyone tell me what it is? (bite and chew food) That's right! With a healthy mouth and strong teeth we can bite and chew all kinds of good foods. If we didn't have teeth, we couldn't chew our food and we would have to eat only soft food, like baby food, all the time. What food could you not eat if you didn't have teeth?

There's something else we all do with our mouth. I'm doing it right now. Can anyone guess what it is? That's right! We use our mouth and teeth to speak clearly. If you didn't have a mouth, it would be hard to say the ABC's. I wouldn't be able to understand you when you talk to me. Try to say "Hi, Smiley" without moving your mouth. Oh, my. I couldn't even understand you. Now move your mouth and say "Hi, Smiley" very clearly. Oh, much better! Well, now we must remember to keep our mouth and teeth healthy so we can smile nicely, chew our food, and speak clearly. See you next time! Bye!





Parent Letter: "Functions of the Mouth"

Dear Head Start Parent:

Today your child learned about the many ways people use their mouth. The mouth is used to chew, to speak, and to smile. Your child's baby teeth are very important. They save space for the permanent teeth to grow in straight and healthy. They also help your child learn to speak clearly.

To help your child remember the important uses of the mouth, you and your child might go through old newspapers or magazines and cut out pictures of people who are using their mouth. Have your child describe the ways the mouth is being used in the pictures you find.

Head Start is concerned with helping your child have a good self-image, and we know you want that also. A good self-image helps children to succeed. Happy smiles with healthy teeth are important in creating that good self-image.

Sincerely,

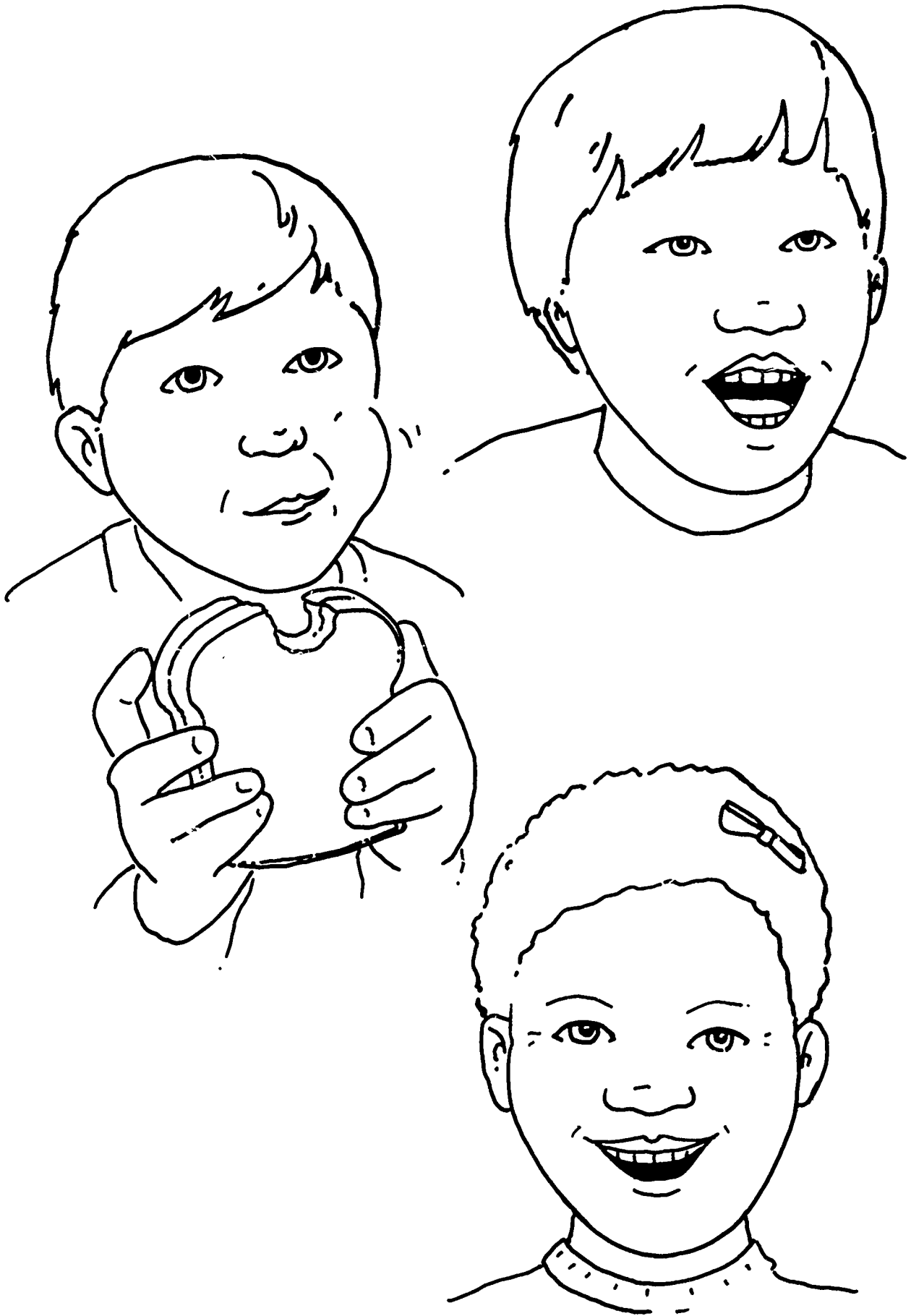

**LESSON:**

**THE IMPORTANCE OF KEEPING TEETH  
AND GUMS CLEAN**

**Purpose:**

To create an awareness that teeth and gums need to be cleaned thoroughly each day.

**Materials Needed:**

Activity Page, "What We Use to Keep Clean"  
Activity Page, "Finger Puppets"  
Parent Letter, "The Importance of Keeping Teeth and Gums Clean"  
Attachment to Parent Letter, "Nursing Bottle Mouth"

**Background  
Information  
for the Teacher:**

The teeth should be cleaned every day to remove plaque. Plaque is a soft, sticky, colorless film of bacteria and byproducts that forms on the teeth. The bacteria are most harmful when they have organized into colonies, which takes about 24 hours.

The bacteria in plaque are a major cause of tooth decay and gum disease. When foods containing sugars and starches are eaten, the bacteria produce acids and other irritants. The acids attack the tooth enamel for about 20 minutes. After many acid attacks, tooth decay may occur. The other irritants affect the gums, causing them to become swollen and bleed easily. Over a long period of time, untreated gum disease can destroy the bone that supports the teeth. Healthy teeth can become loose and fall out or may need to be removed.

Starting the Lesson:

Begin the lesson by reviewing with the children the reasons why teeth are important and what our teeth help us to do (smile, talk, chew). Give children an opportunity to sing one of the songs that they have learned about teeth.

A. Ask the children the following questions:

"When do you wash your hands?"

"Why do you wash your hands?"  
(Elicit from children responses such as "to clean off dirt" and "to remove germs.")

"Can you see dirt on your hands?" (Yes)

"Can you see germs on your hands?" (No)

"How do you clean your hands to get the dirt and germs off?"  
(Wash with soap and water.)

"Show me how you clean your hands." (Have children show motion of rubbing hands.)

"What would happen if you didn't wash your hands?" (Encourage responses such as you might get dirt in your food; you might get sick; a scratch or cut might not get better.)

Explain to children that we wash our hands to clean off the dirt and remove the germs even though we don't see the germs.

Another place where there are germs that we cannot see is in our mouth. These germs need to be cleaned off too.

B. Ask children the following questions.

"How do you clean your mouth to get rid of the germs?" (Brush my teeth.)

"What do you use when you clean your teeth?" (Toothbrush and toothpaste.)

"What would happen if you didn't clean your teeth?" (Explain that just as we can get sores on our hands or get sick when we don't keep our hands clean, our teeth get sick and hurt if we don't keep them clean.)

Classroom  
Activities:

1. Matching Activity - Cut out and distribute the six boxes shown on Activity Page, "What We Use to Keep Clean" to each student. Have children match the item to be cleaned with the item used for cleaning. They may place the matched items side by side and glue the sets on construction paper.
2. Flash cards can also be constructed using the pictures on Activity Page, "What We Use to Keep Clean" by gluing the pairs back to back. When showing one side, you may give children the opportunity to tell what appears on the other side.
3. Game "Keeping Clean Charades" - Ask one student to act out one of the following activities:

Washing hair	Washing arms
Washing hands	Washing legs
Washing face	Washing ears
Brushing teeth	Washing neck
Washing feet	Taking a shower
Taking a bath	Washing tummy

Give other students a chance to guess the charade. The student who guesses what is being portrayed may be the next child to role play cleaning another part of the body. Continue this activity until all students who want to participate have had a chance.

4. "Simon Says" - Using the same phrases as were used for the charade game, play a game of "Simon Says," having children make appropriate motions according to what "Simon Says."

5. Finger Puppet Story

Using Activity Page, "Finger Puppets," cut out and distribute finger puppets of "tooth" finger puppet and one "toothbrush and toothpaste" finger puppet for each child. To start the activity, the teacher should give examples of what his or her puppets would say to each other. For instance: Tooth Puppet, "I feel dirty, will you clean me?" Toothbrush and Toothpaste Puppet, "Yes, I'm good at keeping teeth clean." Give each child who volunteers an opportunity to create a puppet story by responding to the following:

"If the tooth could talk to the toothpaste and toothbrush, what would it say?"

"If the toothbrush and toothpaste could talk to the tooth, what would they say?"

Lesson Review,  
Puppet Story:



Hi, boys and girls! I'm so happy to see all of you again. Today you learned about washing your hands and face. Who would like to tell me why we wash our hands and face? (To clean off dirt and



to remove germs) Very good! Do you know that we can see dirt on our hands and face, but we can't see germs? Can someone tell me what could happen if we didn't wash our hands and face? (Dirt could get into our food; germs could make us sick.) That's right! Of course, we also wash all the other parts of our body too, such as our ears and neck. These are places where dirt and germs can hide.

Our teeth also need to be cleaned to remove food and the germs that are hiding there. Clean teeth are healthy and shiny. Who would like to tell me what we use to clean our teeth? (Toothbrush and toothpaste) Very good! We need to brush our teeth very carefully every day. I'm glad you know why we need to keep clean and brush our teeth every day. The next time we meet we're going to talk a lot more about brushing. Your teacher will even show you how to brush with your very own toothbrush. See you soon!



Parent Letter: "The Importance of Keeping Teeth and Gums Clean"

Dear Head Start Parent:

Today your child learned why it is important to clean teeth and gums daily--to remove plaque. Plaque is a sticky, colorless film of bacteria (germs) that constantly forms on the teeth. The bacteria make acids and other waste products that cause tooth decay and gum disease.

Because plaque forms every day, it must be cleaned off every day. If this is not done, it builds up and becomes more harmful. As you know, your child's baby teeth are very important and should be cleaned every day to keep them healthy. We will be making sure your child is brushing every day at the Head Start Center and will be encouraging him or her to brush at home as well.

You can help your child by making sure that toothbrushing is part of the daily routine. Also, your own example of daily brushing and flossing would be another way to teach your child about the importance of cleaning teeth. If you have babies or young children who feed from a baby bottle, please be sure to read the page about Nursing Bottle Mouth that was sent with this letter.

Sincerely,



## NURSING BOTTLE MOUTH

Sometimes babies or young children who drink from a baby bottle develop a condition called "Nursing Bottle Mouth." Nursing bottle mouth is a dental condition that can destroy the teeth of an infant or young child. The teeth most likely to be damaged are the upper front teeth, the ones that can make such a difference in your child's smile. But other teeth may also be affected by this condition.

Nursing bottle mouth is caused when liquids such as milk, formulas, juices, or sweet drinks pool around a child's teeth for long periods of time. This can lead to decay. That's why giving your child a bottle containing these liquids many times a day, as a pacifier, isn't a good idea. You also should not allow your child to fall asleep with a bottle during naps or at night, or else your child's teeth can be seriously harmed.

You can prevent this from happening to your child's teeth by protecting them in the following ways:

- \* After each bottle feeding, wipe the child's teeth and gums with a damp washcloth or gauze pad, to remove plaque.
- \* Never allow your child to fall asleep with a bottle containing milk, formula, fruit juices, or sweetened liquids.
- \* If your child needs a comforter between regular feedings, at night, or during naps, fill a nursing bottle with cool water or give the child a clean pacifier recommended by your dentist. (Never give your child a pacifier dipped in any sweet liquid.)
- \* Avoid filling your child's nursing bottle with liquids such as sugar water, sweetened gelatin, and soft drinks.

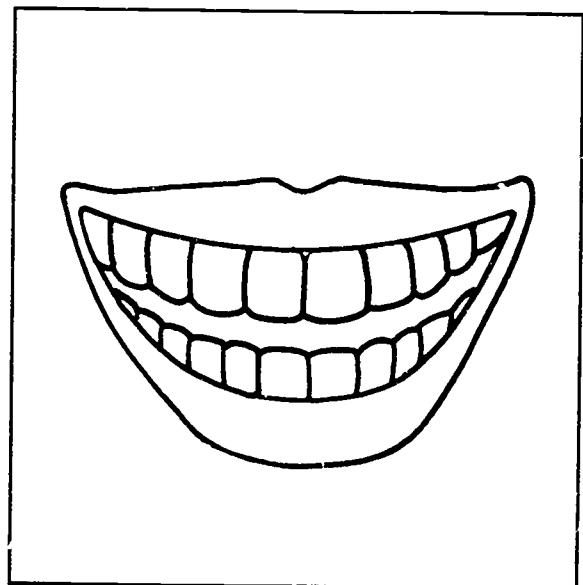
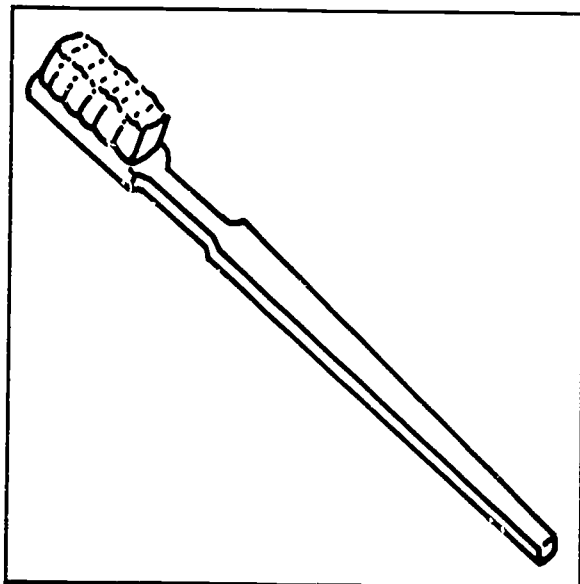
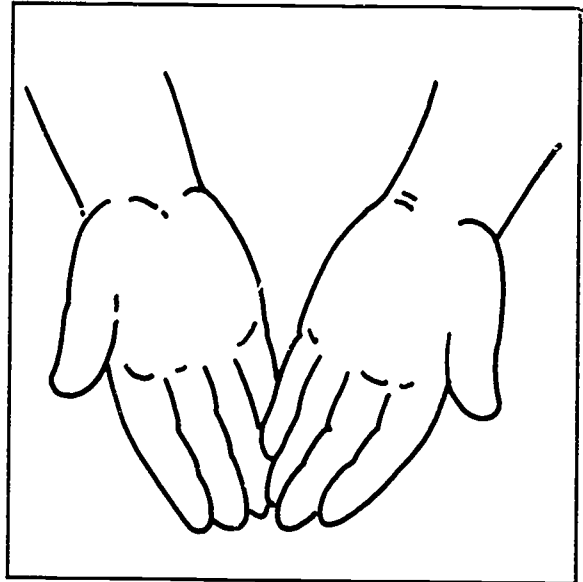
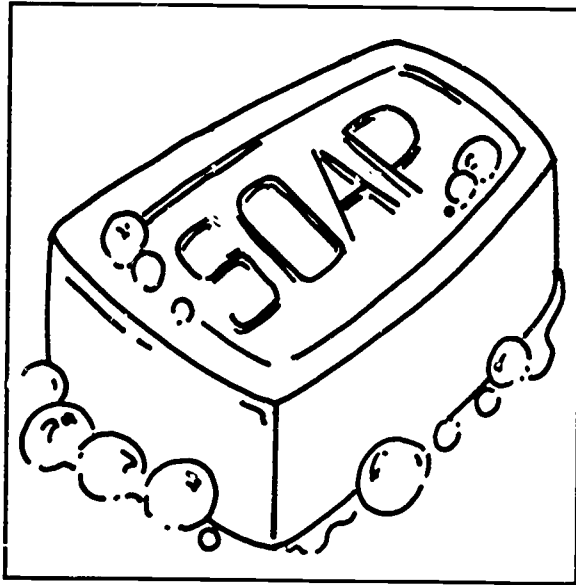

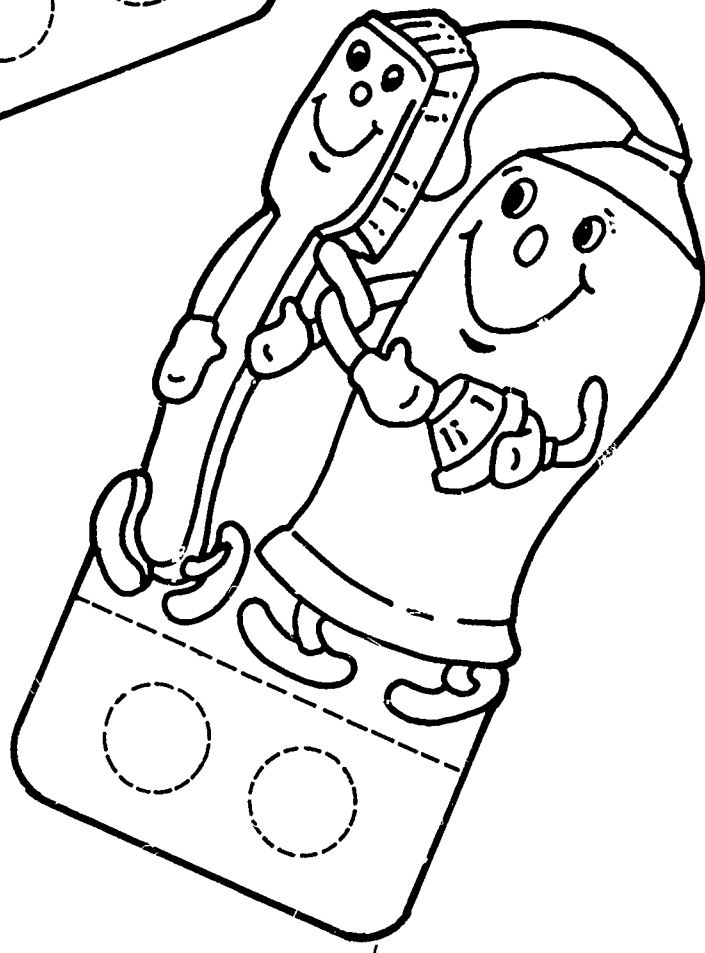
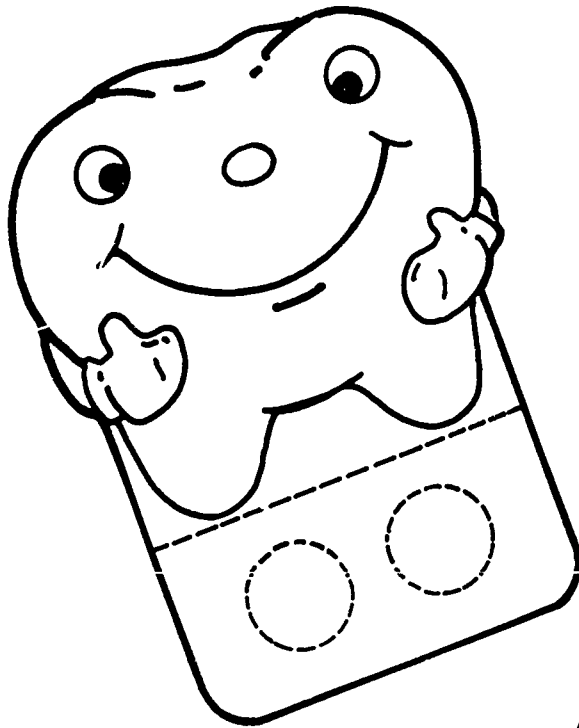

**LESSON:**

**TOOTHBRUSHING**

**Purpose:**

To develop toothbrushing skills.

**Materials Needed:**

Toothbrush for each child  
Fluoride toothpaste with ADA Seal of Acceptance  
Small paper plates or construction paper  
Paints or crayons  
Glue  
Yarn (optional)  
Wooden sticks  
Activity Pages, "How to Brush"  
Rolled pieces of masking tape, small pieces of velcro, or small pieces of felt  
Large mirror (optional)  
Activity Page, "Toothbrush Pattern"  
Parent letter, "Toothbrushing"  
Attachment to Parent letter, "Toothbrushing Chart"

**Background Information for the Teacher:**

**Brushing:** The prevention of dental disease depends on the complete removal of plaque from all surfaces of the teeth. Cleaning each tooth carefully is very important. The teeth should be brushed daily to remove plaque from the outside, inside, and biting surfaces. A number of ways of toothbrushing are acceptable. Here is a method that is often suggested:

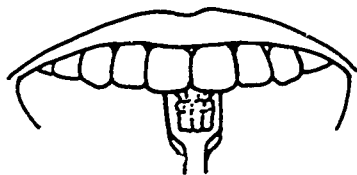
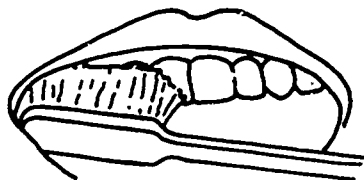

Place the head of the toothbrush beside the teeth, with the bristle tips at a 45° angle against the gumline. Move the brush back and forth sideways in short (half-a-tooth-wide) strokes several times, using a gentle scrubbing motion. Scrub the outside, inside, and chewing surfaces of all the teeth. To clean the inside surface of the front teeth, tilt the brush and make several up-and-down strokes with the front part of the brush. Brush gums and teeth.

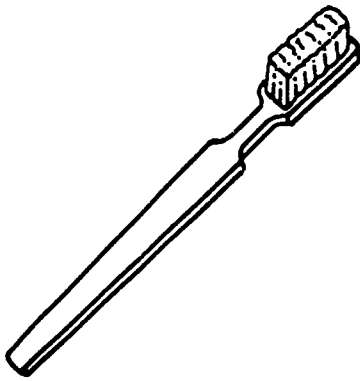

Most dentists recommend using a toothbrush with soft, end-rounded or polished bristles. This type of brush is less likely to injure the gums. The size and shape of the toothbrush should allow every tooth to be cleaned. Children need brushes smaller than those made for adults. Brushes should be replaced often (usually every three or four months), as worn-out brushes do not clean the teeth well.

### Starting the Lesson:

The following steps have been designed to help children become aware of all the surfaces of their teeth that must be cleaned each time they brush. Since some children will not understand some terms, such as inside, outside, top, bottom, etc., it is important for you to demonstrate and have the children imitate each of the following steps. You may want to conduct this activity as a "Follow the Leader" game with yourself as leader and the children following your directions for each step.

Begin lesson by having the children wash their hands. Say to children, "It is important for your hands to be clean because we are going to be putting them in our mouth to feel all the parts of our teeth."

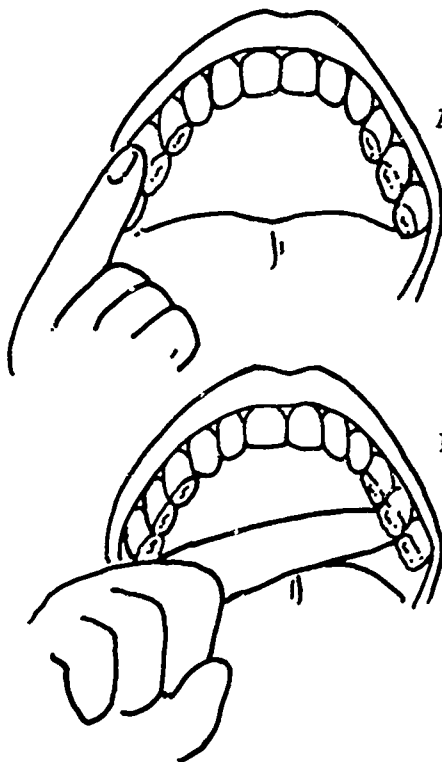

A. "First we're going to touch the outside of all of the top teeth." Have children imitate you as you place a finger on the farthest back tooth on one side of your mouth and slowly move your finger across to the other side of your mouth, touching the outside surface of each tooth as you move your finger across.

B. "Now we are going to touch the inside of all the top teeth." Have children imitate you as you touch the inside of the top back tooth on one side of your mouth and slowly move your finger across the inside surfaces of all the top teeth, gently rubbing each tooth

from one end of the mouth to the other end.

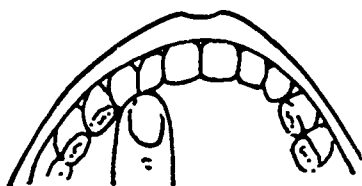

- C. "Now we are going to touch the biting and chewing surfaces of all our top teeth." Have children imitate you as you touch the biting and chewing surfaces of all your top teeth.

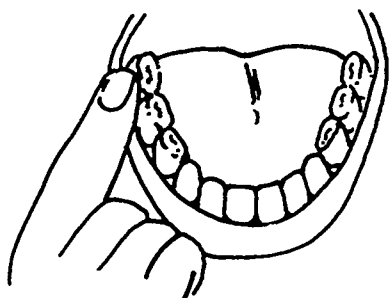

- D. "Now let's feel the outside of all our bottom teeth." Have children imitate you as you place a finger on the farthest back tooth on one side of your mouth and slowly move your finger to the other side of your mouth, touching the outside surface of each tooth as you move your finger across.

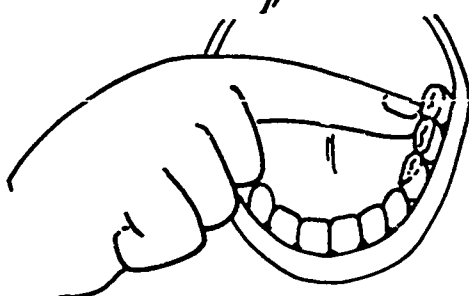

- E. "Now we are going to touch the inside of all the bottom teeth." Have children imitate you as you touch the inside surface of the bottom back tooth on one side of your mouth and slowly move your finger across the inside surfaces of all the bottom teeth, gently rubbing each tooth from one end of the mouth to the other end.

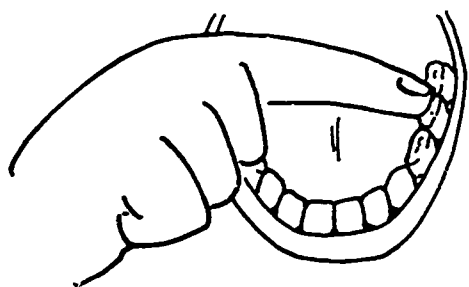

- F. "Now we are going to touch the biting and chewing surfaces of all our bottom teeth." Have children imitate you as you touch the biting and chewing surfaces of all your bottom teeth.

Conclude this awareness activity by telling children that when they brush their teeth they should be sure to touch every side of every tooth with their toothbrush, just like they have touched every tooth with their finger.

#### Classroom Activities:

Note: If sink and water facilities are available, you may use the following procedure. Distribute toothbrushes to each student. Have students form a line; put a dab, the size of a small pea, of fluoride toothpaste on each child's brush. Have children go to the place where they will be brushing. Instruct them to brush with

toothpaste, using the same methods that they have practiced. After they have brushed, encourage them to thoroughly rinse their mouth with water and rinse their toothbrush so that there is no toothpaste left on the toothbrush.

Color Activity Pages, "How to Brush." If possible, mount these pictures on heavy paper or cardboard. You may want to cover the pictures with a clear plastic material to protect them. Display these pictures in the area where the children will be brushing to help remind them of the proper toothbrushing method.

If toothpaste and/or water is not available, have the children brush using a dry toothbrush by itself. This is also an effective way to clean teeth. When children "dry brush," they can do so in small groups at their tables, or in small or large circles. If at all possible, toothbrushes should be thoroughly rinsed and dried after each use.

1. Toothbrushing Activity - Have students wash their hands. Distribute toothbrushes to each student. Explain that they now are going to use the toothbrush to clean their teeth and that the toothbrush should touch all the teeth that they have touched with their finger. (Toothpaste is not to be used for this practice brushing exercise.)

For the proper toothbrushing technique to be understood, it may be necessary to spend one or two days on the following toothbrushing instructions:

## Toothbrushing Instructions for Head Start Classroom

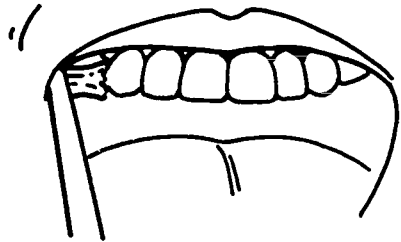

- (1) Introduction - Have students wiggle the brush bristles on one of their fingers. Explain that this is the same movement the brush will make on their teeth.

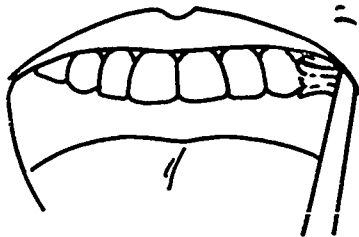

- (2) Starting at the very farthest back tooth on the outside surface of the top teeth, gently wiggle the brush against each and every tooth, moving from the back to the center front top tooth.

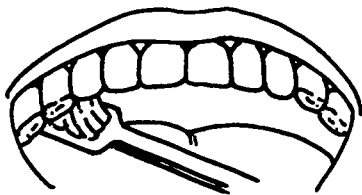

- (3) Move brush to top back tooth on the other side of the mouth and gently scrub by wiggling the brush against each and every tooth, moving from the back to the center front top tooth.

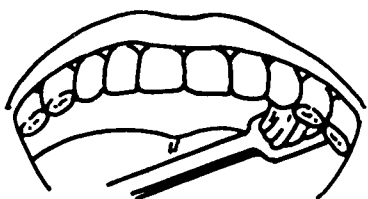

- (4) Now start at the very farthest back tooth on the inside surface of the top teeth. Gently scrub by wiggling the brush against each and every tooth, moving from the inside of the back tooth to the center front top tooth.

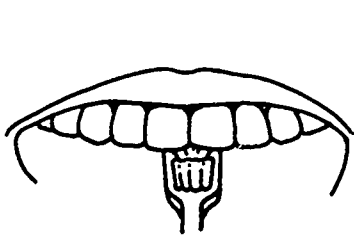

- (5) Move brush to the inside surface of the farthest back tooth on the other side of the mouth and brush every tooth from the back to the center front tooth.

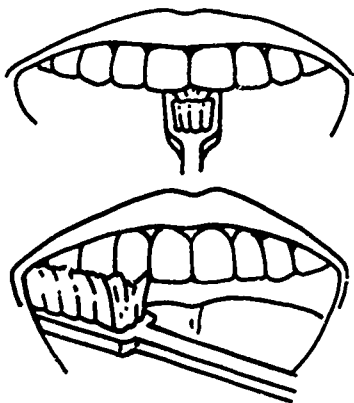

- (6) Place toe (top part) of brush against back part of top front teeth, and very gently brush up and down.

- (7) After brushing the inside and outside surfaces of the top teeth, instruct children to brush the biting and chewing surfaces of their top teeth, starting with the farthest back tooth on one side, and brushing to the center front tooth. Then brush the chewing and biting surfaces of the top teeth on the other side of the mouth.



- (8) Repeat the preceding 6 steps for the bottom teeth.
- (9) Explain to children that they should follow this brushing method every time they brush.

Tips for Toothbrushing: The following are general guidelines that can be helpful while you supervise your children as they brush their teeth:

- A. Note whether the child is following the toothbrushing sequence.
- B. As the children are brushing each day, be sure to emphasize all the areas of the mouth that should be cleaned. Say such things as "Be sure to clean all the outside surfaces of the teeth, all the inside surfaces of the teeth, and the chewing surfaces of the teeth, both 'top' and 'bottom.'" Try to use the following phrases to the children to reinforce their brushing habits and to develop positive self-concepts:  

"You're doing a good job." "Your teeth look sparkling." "What a nice smile you have." "You're a very good brusher." "I like looking at your clean smile." "You should be proud of what a good job you've done cleaning your teeth." Etc.
- C. Make sure children are using short, back-and-forth, gentle scrubbing actions.
- D. The mouth should be partially open. Encourage children to open their mouths gently and not to "stretch" their jaws.
- E. Discourage chewing on brushes or scrubbing too hard, as these practices wear out toothbrushes.
- F. Watch for ineffective toothbrushes that are bent or frayed, and replace them. Worn-out toothbrushes cannot clean the teeth and may hurt the child's gums.

- G. When children are brushing their teeth, be sure to brush with them so that they will have a good role model.
- H. If possible, place a mirror near the place where the children will be brushing. Be sure the mirror is placed at the children's eye level so they can watch themselves.
- I. Have each child thoroughly rinse his/her toothbrush and mouth, if possible.

Toothbrush Storage in the Head Start Classroom:

It is very important that each toothbrush be stored in such a way as to minimize the spread of germs. Even when toothbrushes are thoroughly rinsed, germs continue to live on a wet brush. For this reason, it is important that toothbrushes be stored so that they can air dry between brushings and so that moisture from one toothbrush does not drip onto another brush. Following are ways that toothbrushes can be stored safely in the Head Start classroom.

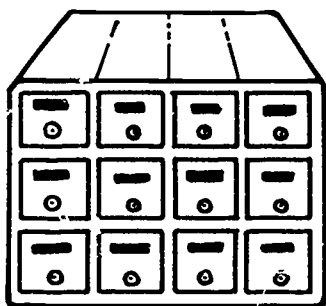

- \* Obtain a plastic cabinet with drawers, available in various sizes from hardware stores. Assign a drawer for each student's toothbrush. Using indelible ink, make a label for each drawer. It is important that air circulate between each drawer so that brushes can dry completely. Be sure drawers are not air tight. It is also important that drawers not contain holes, which would allow water from one toothbrush to drip on another.

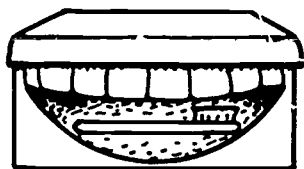

- \* Have each child decorate a shoe box using a dental theme. The decorated shoe box can be kept in the student's desk or locker where his/her labeled toothbrush may be stored.

\* It is not a good idea to store brushes in community jars, egg cartons, or by hanging them together from nails in the wall if these methods allow the brushes to drip on each other. Sealed containers that are air tight are also undesirable because they prevent air drying.

2. Music Activity - After practicing this method of toothbrushing, teach children the following song, "This is the Way We Brush Our Teeth," sung to the tune of "Here We Go Round the Mulberry Bush." Have children motion as though they are holding a toothbrush, moving it from one side of the mouth toward the center. When the verse is repeated, have them also repeat the motion for the other side of the mouth. For the final verse, have children motion as though they are gently scrubbing the chewing surfaces of their teeth.

This is the way we brush our teeth,  
Brush our teeth, brush our teeth,  
This is the way we brush our teeth,  
Move to the front.

(Repeat)

This is the way we brush our teeth,  
Brush our teeth, brush our teeth,  
This is the way we brush our teeth,  
Clean the insides too.

(Repeat)

(Have children motion as though they are gently scrubbing the chewing surfaces.)

This is the way we brush our teeth,  
Brush our teeth, brush our teeth,

This is the way we brush our teeth,  
Scrub where we chew.

(Repeat)

After the children have learned this song, make a cassette recording of them singing it. Play the song as the children are brushing their teeth to serve as a reminder of the brushing pattern that should be followed. If you are unable to make a recording of the song, you may want to sing the song as the children are brushing.

3. Art Activity - Reinforce the concept of various colors by asking students to identify the color of his/her toothbrush. When new toothbrushes are distributed, discuss the color. Give each student an opportunity to name an object in the room that is the same color as their toothbrush.
4. Music Activity - Teach children the following song, "Are My Teeth Clean," sung to the tune of "Are You Sleeping, Brother John?" Have them sing the first verse before they are ready to brush each day. The second verse may be sung after they have cleaned their teeth. The song may also be sung while the toothpaste is being dispensed. While singing verse one, children may also shake their head "no" when they are saying "No, They're Not; No, They're Not." And, when they are singing verse two, they may shake their head up and down for "yes" when they are saying "Yes, They Are; Yes, They Are."

Verse one:

Are my teeth clean?

Are my teeth clean?

No, they're not!

No, they're not!

Let's go off and brush them,  
Let's go off and brush them,  
Right away,  
Right away.

(Repeat)

Verse two:

Are my teeth clean?  
Are my teeth clean?  
Yes, they are!  
Yes, they are!  
" "  
We are good at brushing,  
We are good at brushing,  
See our smile,  
See our smile.

(Repeat)

5. Art Activity - Distribute small paper plates or circles made from construction paper, giving one to each student. Provide materials so that students can make a happy face on a small paper plate or on a circle of construction paper. Provide materials such as paints or crayons, pieces of construction paper, glue, and yarn so that hair and parts of the face can be made and placed on the paper plates to make a happy face. When the puppet is completed, attach the face to a tongue depressor or some similar wooden stick so that each child will have a "Happy Face" stick puppet. The "Happy Face" stick puppet will be used in other lesson activities.

Have children hold up the "Happy Face" stick puppets while they sing the

second verse of "Are My Teeth Clean," after having cleaned their teeth.

6. Numbers Activity - Use the pattern found on Activity Page, "Tooth Pattern" to make ten toothbrushes for use on a flannel board. Have children count the toothbrushes as you place them one by one until there are ten on the flannel board. If children have not mastered counting from one to ten, postpone this activity.

Lesson Review,  
Puppet Story:



Hi, everybody! I know you have been learning a lot about toothbrushing. Have you all used your finger to touch each tooth in your mouth? Wow, you have lots of teeth! Can someone tell me what teeth feel like? (Wet, warm, hard) Very good! Did some teeth feel big and bumpy? Did some teeth feel smooth and sharp? Did you also feel your gums? Who can tell me what your gums feel like? (Wet, warm, soft) Terrific! Do you remember the last time we talked about cleaning our nice, shiny teeth? Every tooth needs special care to keep it clean and healthy. We said that we need to clean our teeth every day so that germs don't hurt our teeth.

We have to brush every side of every tooth. Can you point to your top teeth? I'm going to open my mouth wide. Who can point to my top teeth? Where are your bottom teeth? What do you use to brush your teeth? Good! Can you tell me the color of your toothbrush? Toothbrushes help clean your teeth just like washcloths help clean your hands and face. Don't forget to rinse your mouth with lots of water when you have finished brushing. Next time we meet we'll talk about something very special for your teeth. See you then!



## Parent Letter: "Toothbrushing"

Dear Head Start Parent:

As part of our lessons on dental health, your child has been taught why the teeth need to be cleaned every day. Now the children are learning how to clean the teeth. We have given your child a toothbrush to use in the classroom. You will want to make sure your child has a toothbrush to use at home, too. Here are some tips on brushing your child's teeth.

Children of Head Start age can begin to learn to brush their own teeth. An adult must help, however, to see that they brush well. Get your child a brush with a small child-size brush and soft, polished bristles. A hard-bristled brush can hurt your child's teeth and gums. When using toothpaste, be sure it contains fluoride. Only a dab, the size of a pea, is necessary. If you do not have toothpaste, encourage your child to use the toothbrush by itself. Replace the brush when the bristles look bent, usually every three or four months. A worn-out toothbrush cannot clean teeth and may hurt your child's gums.

There are a number of good ways of brushing the teeth. Here's the brushing method your child has learned in Head Start:

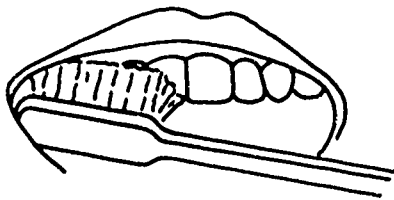

- \* Hold the brush against the gumline. Point the bristles toward the gums.
  
- \* Move the brush back and forth with short half-a-tooth-wide strokes, using a gentle scrubbing motion.

- \* Brush the outside surfaces of the teeth, the inside surfaces, then the chewing surfaces.

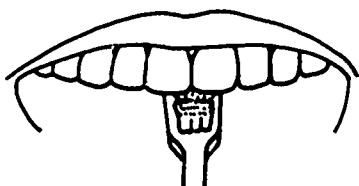

- \* To clean the inside surfaces of the front teeth, tilt the brush straight up. Make several up-and-down strokes with the front part of the brush.

In addition to brushing, be sure to use dental floss in order to remove plaque (an invisible layer of germs) from between the teeth. However, young children should not floss by themselves; have your dentist or dental hygienist show you how to floss your teeth and your child's teeth. By flossing your teeth you will be presenting a good example for your child to follow.

To encourage your child to brush his or her teeth, you can put up the chart we have provided showing the days of the week. Every day that the child brushes, draw or paste a brightly colored star on the chart. It is a good idea to brush your teeth along with your children. If your child cannot brush his or her own teeth, you may want to hold your child on your lap while helping brush his or her teeth.

When not in use, brushes should be left uncovered so that the air can dry them. When toothbrushes are put away, be sure that the brush heads are placed so that they do not touch or drip on each other. To prevent spreading germs, each family member should have his or her own brush. By helping your child develop good dental habits today, you help your child have good health tomorrow.

Sincerely,



Name	Sunday	Monday	Tuesday	Wednesday	Thursday	Friday	Saturday
	Brush	Brush	Brush	Brush	Brush	Brush	Brush

Toothbrushing Chart



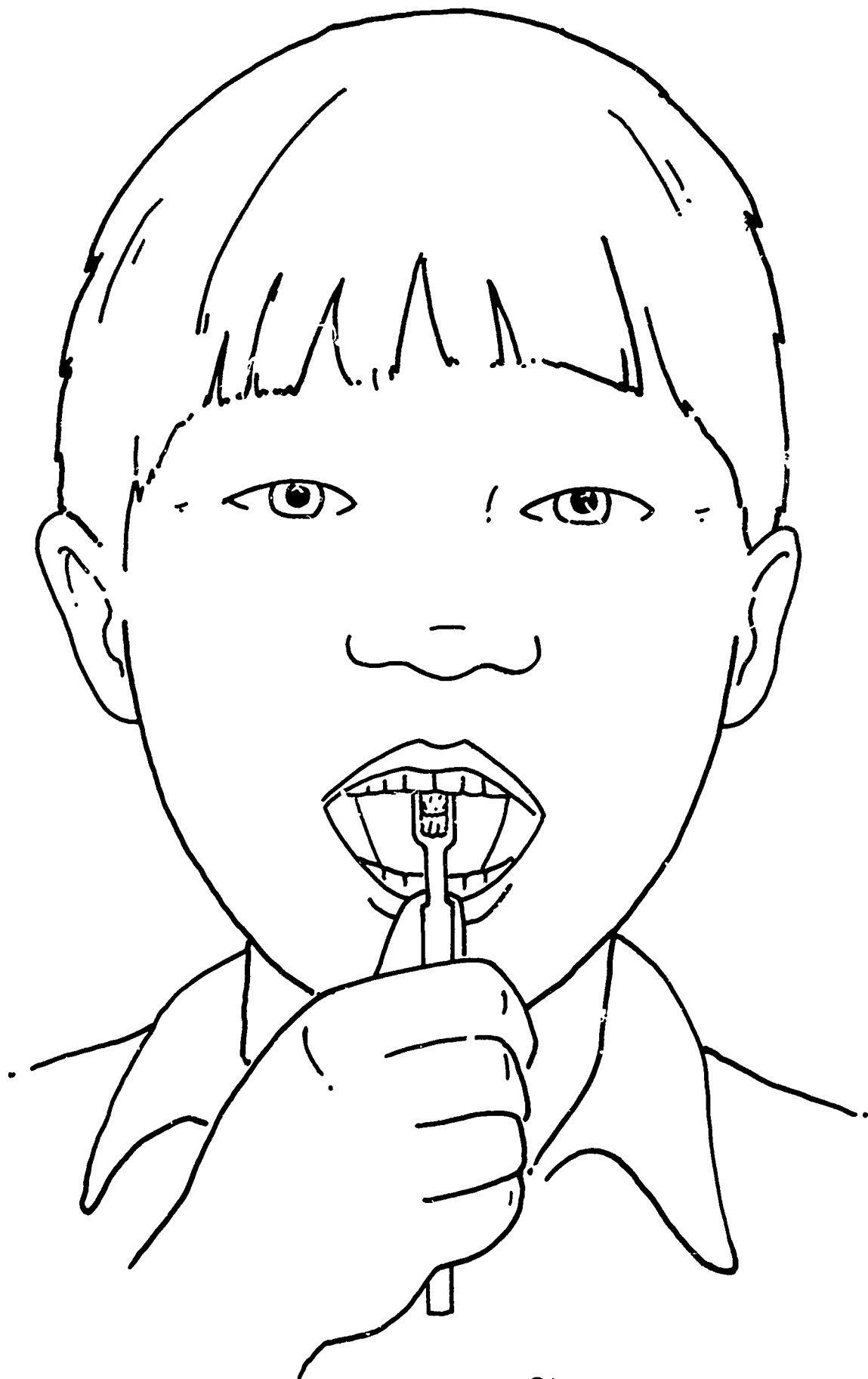





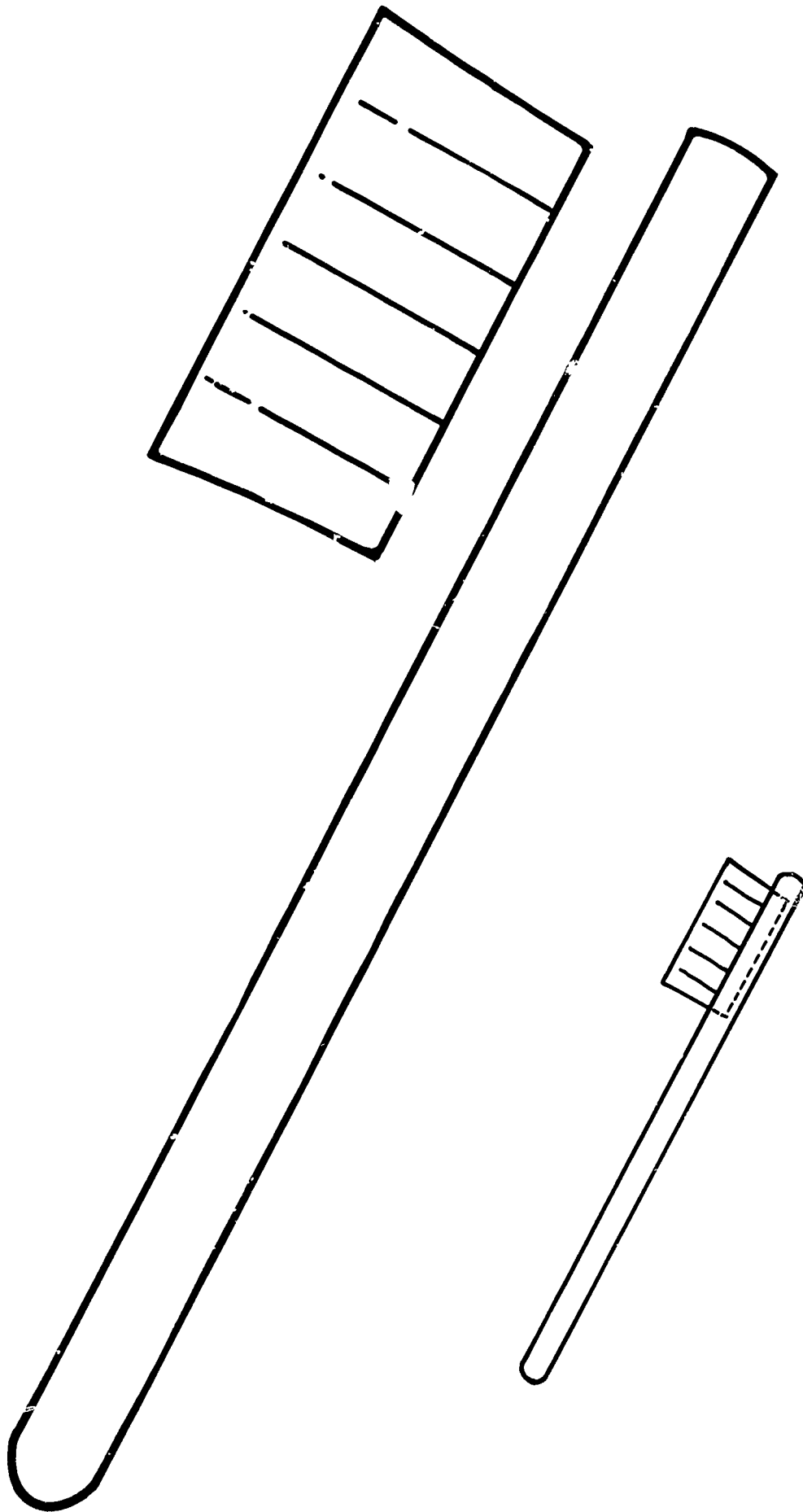

**LESSON:**

**THE IMPORTANCE OF FLUORIDE AND SEALANTS**

**Purpose:**

The purpose of this lesson is to create an awareness among teachers, students, and parents of the importance of fluoride and sealants and the various ways of obtaining these two protective agents.

**Materials Needed:**

Crayons  
Two sheets of construction paper for each student  
Activity Pages, "Ways to Get Fluoride" (one set for each student)  
One tube of toothpaste that has the ADA Seal of Acceptance on it (optional)  
Parent Letter, "The Importance of Fluoride and Sealants"  
Attachment to Parent Letter, "Ways to Get Fluoride"

**Background Information for the Teacher:**

Fluoride is a mineral that helps teeth become stronger and more resistant to decay. It can benefit both children and adults.

There are many ways Head Start children can get the fluoride they need for good dental health. These include:

- .. drinking water that contains enough fluoride at home or at school;
- .. taking chewable fluoride tablets prescribed by a dentist or physician if fluoride is not available in the drinking water;
- .. using fluoride toothpastes at home;

- .. having fluoride solutions or gels applied to the teeth by a dentist.

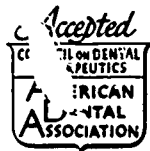

When choosing a fluoride tooth-paste, choose a product that has the American Dental Association's Seal of Acceptance on the carton or tube. These products have been proved effective in reducing the incidence of decay.

It is important for you to work closely with the Head Start Dental Health Consultant and Health Coordinator to be sure the children in your classroom are provided a fluoride program that best meets their needs. This will depend on the level of fluoride available in your school and community water supply.

Sealants are clear or shaded plastic materials that are applied by a dentist to the chewing surfaces of the back teeth. These areas have deep grooves which are very difficult to keep clean. Dentists now can apply a plastic material over these grooves that helps prevent decay from occurring. Dental sealants have proved most effective in preventing decay in children's teeth.

Each tooth takes only a few minutes to seal. First, the teeth that will be sealed are cleaned. A special material is then put on the chewing surface to help the sealant become attached to the tooth. Finally, the sealant is brushed on the tooth enamel and allowed to harden. Some sealants need a special light to help them harden; others do not. Sealants are recommended for all children, even those who receive fluoride treatments or who live in communities with fluoridated water.



Starting the Lesson:

To begin this lesson, it is necessary to have a discussion on ways we make our bodies healthy and strong. Ask the following discussion questions:

- Can you name some things you eat that make you stronger? (Encourage answers such as fruit, vegetables, meat, bread.)
- Can you name some things you drink that make you stronger? (Encourage answers such as milk, water, juice.)
- Can you name some things you do that make your muscles stronger? (Encourage answers such as running, climbing, playing.)

Now explain to the children that there is something that we can use to make our teeth very strong. This is called fluoride (Flor' id). You cannot see fluoride, but it is in some water, toothpaste, and tablets. Have the children practice saying "fluoride."

Use the copy below with the pictures on Activity Pages, "Ways to Get Fluoride." Make copies of the Activity Pages so that each student has his or her own set of pictures.

Have the children look at the appropriate page as you read the copy for each page. If you are unable to make a copy of the pictures for each student, you may instead color one set and display them when you read aloud the copy for each page.

Page 1 - "Sometimes the dentist or hygienist will put something special on your teeth. It looks like jello, comes in many flavors, and contains fluoride.

Fluoride will help make your teeth strong. What else do you see in the picture?"

Page 2 - "Some tubes of toothpaste have a special picture on them. If you see this picture on your toothpaste tube, you will know your toothpaste has fluoride in it. Can you find the special picture on any of the toothpaste tubes on the page? How many toothpaste tubes have the special picture? Can you point to the toothpaste tube that does not have the special picture on it? Be sure to use toothpaste that has the special picture on it."

Page 3 - "Brushing with fluoride toothpaste every day will make your teeth stronger. Where do you see the special picture on this page?"

Page 4 - "Fluoride also comes in special tablets that we may get at home or school. These tablets can also make our teeth stronger. You should take a tablet only if it is given to you by your teacher, your parent, or your dentist."

(Optional: Use this last picture only if your class participates in a fluoride tablet program.)

**Classroom  
Activities:**

1. Coloring - Allow children to color Activity Pages, "Ways to Get Fluoride." Staple the pages together to form a booklet for each child. You may want to give each child construction paper so that he or she can make a cover for the booklet.
2. Recognition - Hold up a toothpaste tube and carton (if available) that have the ADA Seal on

them. Point to the Seal on each item, and tell children that this is the special picture that tells us fluoride is in this toothpaste. Allow each child to point to the Seal of Acceptance while you hold the tube and/or carton. You may want to allow the children to pass around the tube so that each has a chance to look at it closely.

3. Field Trip - As part of a unit on community helpers, take the children to the local pharmacy or drug store. Introduce children to the pharmacist. Explain that the pharmacist can help us find dental products that contain fluoride as well as other items that are good for our teeth. Allow children to look for toothpaste cartons that have the fluoride seal.

Lesson Review,  
Puppet Story:



Hi, boys and girls! I know you've been learning about something that makes your teeth strong. It's called fluoride. Can you say "fluoride?" Very good! We need to keep our teeth strong just like we need to keep the rest of our bodies strong. Can you name some things to eat that make you strong? (Meat, vegetables, fruits, breads, etc.) Excellent! Now, boys and girls, do you remember where we can get fluoride to make our teeth strong? (The dentist's office, toothpaste, tablets)

That's right! You can have fluoride put on your teeth when you visit the dental office. And you can get some fluoride when you brush your teeth with a fluoride toothpaste. Do you know where you can get fluoride toothpaste? Why is there a special

picture on some toothpaste tubes? Very good! The picture lets us know there is fluoride in the toothpaste. I'm glad that you know so much about fluoride. Next time we meet we'll talk some more about how we can keep ourselves strong and healthy. See you again soon!



Parent Letter: "The Importance of Fluoride  
and Sealants"

Dear Head Start Parent:

The entire body needs vitamins and minerals for good health. The teeth and bones also need a special mineral called fluoride. Fluoride helps prevent tooth decay. It is also of special benefit to children, because their teeth are still forming in their mouth.

The best way of getting fluoride is by drinking fluoridated water. If the water in your area does not contain enough fluoride, chewable fluoride tablets may be prescribed for your child by the dentist or physician. These tablets should be taken daily until the child is thirteen. Ask your child's physician or dentist if your community's water supply is fluoridated and how your child can get the fluoride needed for good dental health. Attached is an information sheet about fluoride and ways to get fluoride.



You can help your family get fluoride by choosing--and using-- home dental care products that contain fluoride. Fluoride toothpastes are available in the dental products section of most stores. Be sure to look for the ADA Seal of Acceptance when selecting these items. This Seal tells you that these products have been proved effective by the American Dental Association.

Another way to prevent decay is to have a dentist apply a sealant on your child's back teeth. A sealant is a plastic material that your dentist brushes on the chewing surfaces to prevent germs from getting in the deep grooves of the back teeth.

Fluoride and sealants, along with brushing, flossing, good nutrition and regular dental visits, will help keep your child's teeth healthy.

Sincerely,

## WAYS OF GETTING FLUORIDE

### FLUORIDE IN THE DRINKING WATER

Fluoride is a mineral that helps teeth become stronger and helps prevent decay. One excellent way to get fluoride is to drink water that contains the right amount of fluoride. If you are not sure whether your drinking water contains the right amount of fluoride for good dental health, ask your dentist or hygienist. Children who drink water with the right amount of fluoride have fewer cavities.

Using fluoride is one of the safest, most effective, and least expensive ways to prevent tooth decay. Its use is supported by the American Dental Association, the American Medical Association, the American Public Health Association, and many other major health organizations.

### OTHER WAYS OF GETTING FLUORIDE

In addition to getting fluoride through your drinking water, there are other ways you and your family can get protection from fluoride. Your dentist or hygienist can tell you what is best for you and your family.

#### At the Dental Office

If you drink water that does not contain the right amount of fluoride, your dentist or physician may prescribe fluoride tablets or drops for your children to take every day. For maximum protection, fluoride tablets or drops should be taken from birth until the child is thirteen years old. In addition, your dentist may put a fluoride gel on your child's teeth. This helps protect the surface of the tooth from decay.

#### At Head Start

Some schools and Head Start centers give children fluoride tablets. Fluoride tablets are another way of protecting teeth. These tablets are chewed and dissolved in the mouth. The liquid is then swished around the teeth and swallowed.

## At Home

There are also some fluoride products that can be used at home. Even if the water in your area is fluoridated, dental care products containing fluoride should be used at home. You and your family should use a fluoride toothpaste when you brush your teeth. Those fluoride toothpastes that have the Seal of Acceptance of the American Dental Association have been proved effective and safe for daily use.

2

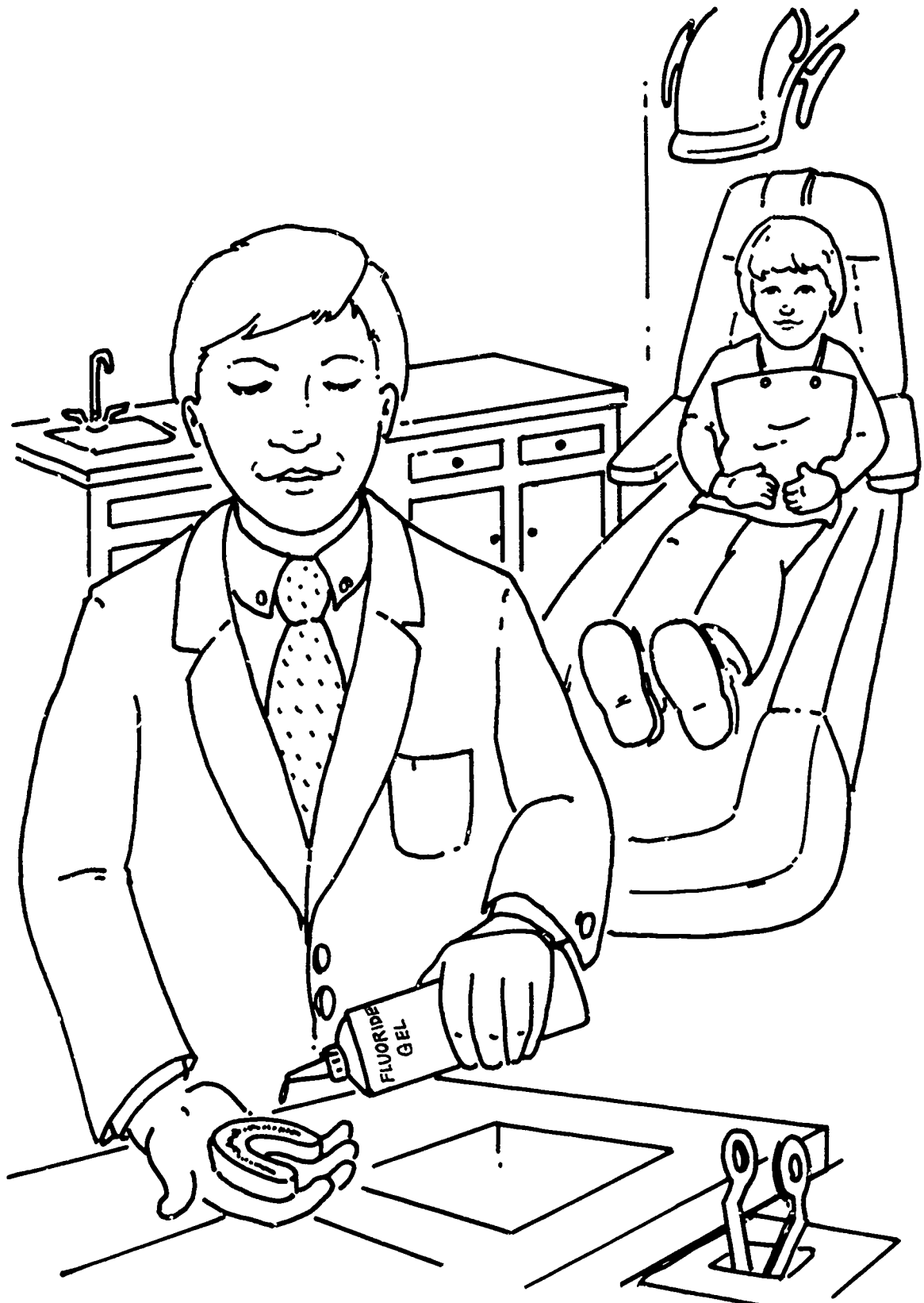

Putting fluoride on teeth will help keep them strong.



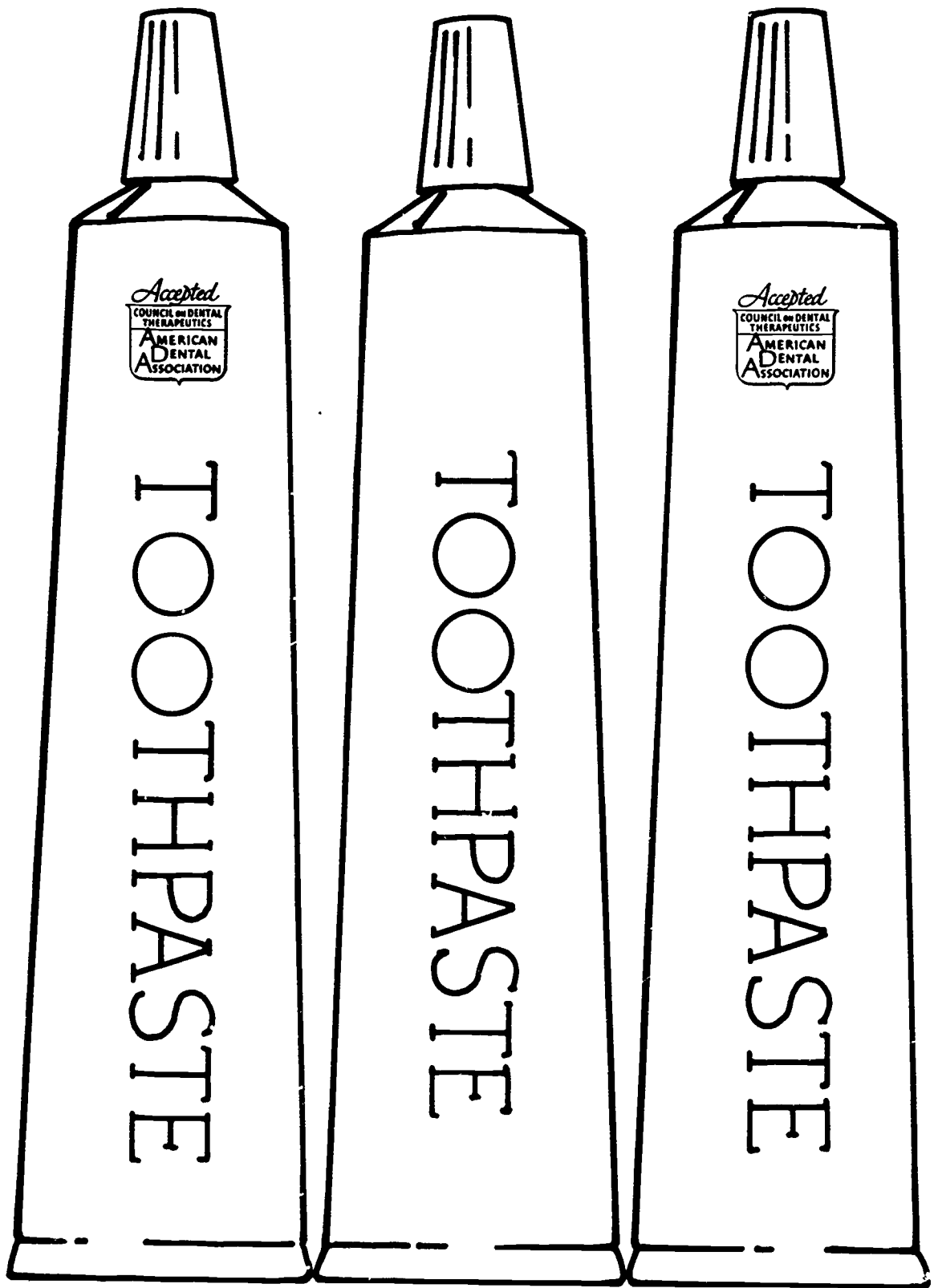

It is best to brush with a fluoride toothpaste.



Use a fluoride toothpaste that has a picture of the seal on it.

A | B | C | D | E | F | G | H | I | J | K | L | M | N | O | P | Q | R | S

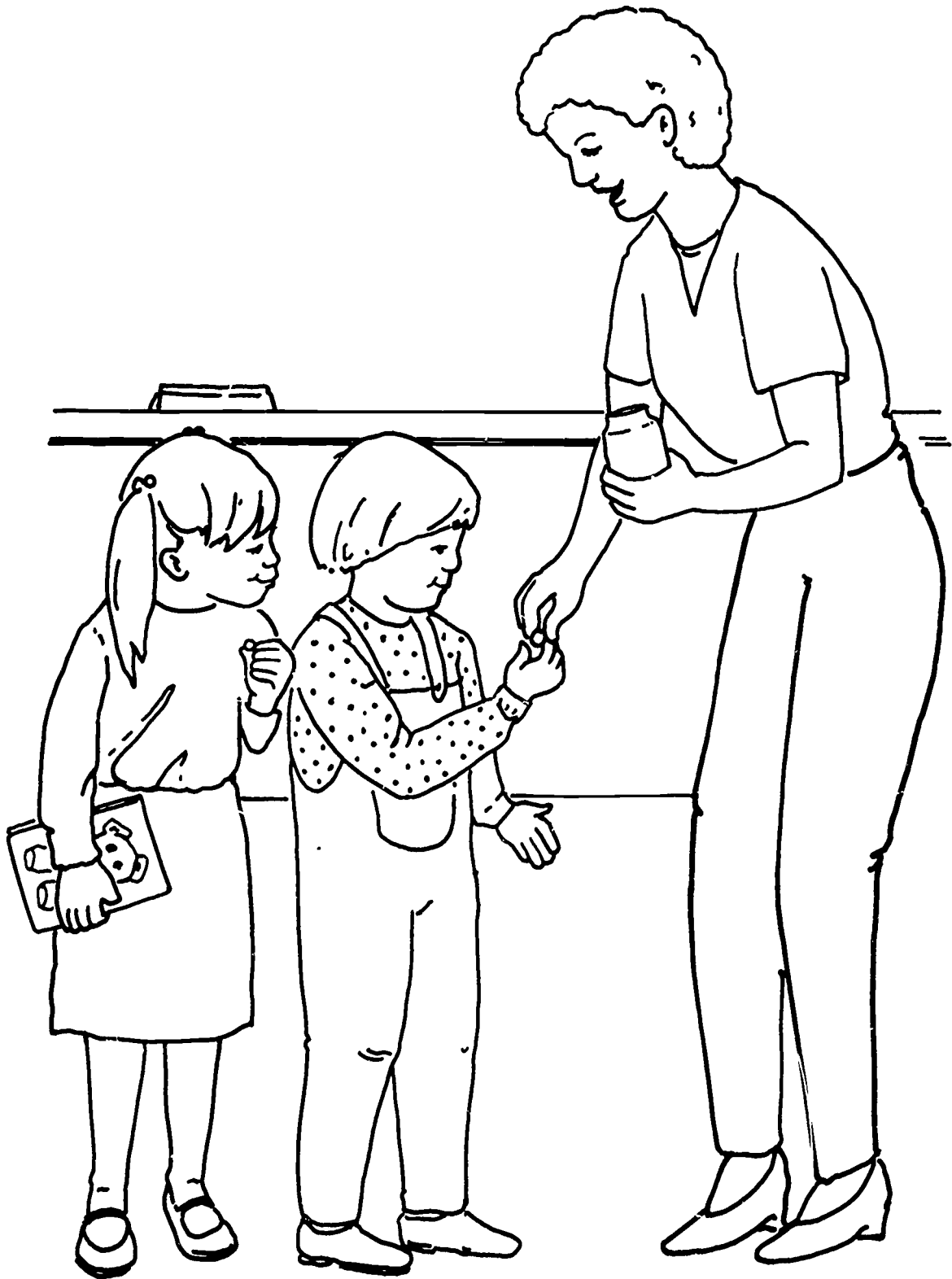

Special tablets have fluoride in them, too.

**LESSON:**

**WISE FOOD CHOICES FOR A HEALTHY MOUTH**

**Purpose:**

The purpose of this lesson is to develop an awareness of the need for wise food choices for meals and snacks.

**Materials Needed:**

Variety of foods (these can be Head Start lunch or snack foods as suggested on p. 65)  
Carrot sticks  
Celery (one 3"-4" piece for each child)  
Sugarless peanut butter or cheese spread  
Sunflower seeds or any similar seeds or nuts  
4" x 6" index cards  
Pictures of foods from old magazines  
Flower pots (optional)  
Vegetable seeds (optional)  
Potting soil (optional)  
Parent Letter, "Wise Food Choices for a Healthy Mouth"  
Attachments to Parent Letter, "Food Selections from the Four Food Groups" and "Sugarless Recipes"

**Background Information for the Teacher:**

For good dental health and overall health, children need to develop sensible eating habits. Here are suggestions based on what is known about how foods affect teeth.

To get the nutrients they need for good overall health, children need to eat a balanced diet. A balanced diet includes the following:

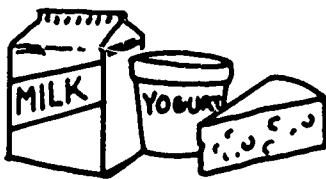

- \* Milk and Dairy Products - 3 servings daily. Examples: Milk (whole, skim, evaporated, powdered), buttermilk, hard cheeses, cottage cheese, yogurt.



- \* Meat, Fish, Poultry, and Eggs - 2 servings daily. Examples: Beef, veal, lamb, pork, liver, chicken, turkey, eggs, fish, dried peas or beans, nuts, and peanut butter without sugar.



- \* Fruits and Vegetables - 4 servings daily. Examples: Oranges, bananas, pineapples, melons, grapes, plums, peaches, pears, apples, and other citrus fruits; white potatoes, sweet potatoes, carrots, tomatoes, string beans, spinach, turnip greens, broccoli, and other green, leafy vegetables.

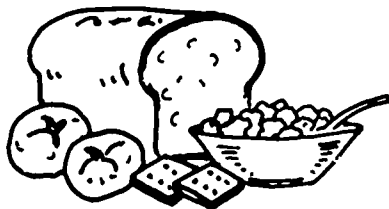

- \* Breads and Cereals - 4 servings daily. Examples: Enriched or whole grain breads, rolls, crackers, macaroni, spaghetti, noodles, rice, oats, corn and wheat products, and cereals.

Small children need to eat some snacks because they cannot eat all the food they need at meals. It is important, however, to select snacks carefully.

Dental researchers know that all types of sugars can promote tooth decay. These sugars include fruit sugar, milk sugar, and grain sugar such as corn syrup and honey. Sugars have many different names, including sucrose, fructose, glucose, lactose, dextrose, and maltose. One or more of these sugars are contained in many foods, such as apples, grapes, pears, raisins, and milk. Even some medicines, such as cough syrups, contain sugars. Because many processed foods have sugars added, you will find it

helpful to read food labels when you shop. Labels list ingredients in descending order, according to weight. The ingredient present in the highest quantity is first on the list. It is important when selecting foods that you read the ingredient label to check for the sugar content. If foods you serve for meals or snacks are packed in a syrup, drain and rinse the food before it is served to remove as much of the sugary syrup as possible.

From a dental point of view, the following snacks are preferred: Cheese, plain yogurt, meat, fish, hard boiled eggs, peanut butter (without sugar), strips of raw vegetables, pretzels, toast, crackers, nuts, popcorn, dill pickles, pizza, refried beans, tortilla chips, cornbreads, tacos.

Although children need some snacks, they should be discouraged from snacking all day long. Because so many foods contain sugars and starches that can cause the bacteria in plaque to produce acids that harm teeth, it is important to limit the number of times a day children snack between meals. This will minimize the number of acid attacks the teeth receive.

In addition, the physical characteristics of the food and the length of time it takes to eat the food play a role in acid production. The longer the food is allowed to remain in the mouth, the more opportunity the bacteria in plaque have to produce acid. Examples of foods that remain in the mouth for a long period of time are raisins, dates, sticky/soft dried fruits (figs, raisins, dates, etc.), sugary breakfast

bars and cereals eaten as a snack, lollipops, breath mints, etc. For these reasons, snacks should be selected wisely.

Please note: Foods cannot be used to clean teeth. Some people used to believe that when you could not brush your teeth, chewing foods such as apples, carrots, popcorn, and celery would serve as a substitute for cleaning the teeth. This is not true. There is no substitute for toothbrushing and flossing.

Children should not snack all day long. Because so many foods contain sugars or starches, almost every time children eat they expose their teeth to an acid attack.

Children should eat reasonable snacks. These snacks should not contain sugars of any kind, as sugars can contribute to tooth decay. (Foods containing sugars should be saved for meals, when they are less harmful to teeth.)

Starting the Lesson:

To begin this lesson on nutrition, we recommend that you ask the following questions after the children have been served their meal or snack. You may want to change the questions based on the food items that are served that day.

"What colors are the foods on your plate?"

"Do any of the foods on your plate have a special shape?"

"Are there any soft foods on your plate?"

"Are there any hard foods on your plate?"

"Which of the foods is your favorite?"

After discussing the foods in their meal, explain to the children that there are many different kinds of food and that it is important to eat many types of food each day. To develop the concept that foods have different tastes, ask the children to describe the various tastes of the foods on their plate. If there are any "finger foods," ask the children to describe how that food feels.

**Classroom  
Activities:**

1. Food Group Cards - Cut out a wide variety of food pictures from magazines, and mount each picture on a 4" x 6" index card. Be sure to select pictures of foods that are familiar to children and that represent all cultures. These foods should also be representative of the four food groups. For your reference, examples of items from the four food groups are listed below:

Milk and Dairy Group

Milk, cheese (Swiss, Cheddar, American, Colby, cottage), and plain yogurt.

Meat, Fish, and Egg Group

Nuts, eggs (esp. hard boiled), ham, chicken, lamb, tuna, shrimp, turkey, hamburger, hot dogs, roast beef, peanut butter, refried beans, and baked beans.

Fruit and Vegetable Group

Fruits: (Fresh and/or packed in water or natural juice.)  
Oranges, grapefruits, tangerines, peaches, nectarines, cherries,



strawberries, grapes, melons, avocados, apricots, and pineapples.

Vegetables: Salad greens, cauliflower, cucumbers, green peppers, tomatoes, radishes, carrots, celery, collards, kale, okra, corn, peas, broccoli, potatoes, and green beans.

#### Bread and Cereal Group

Soda crackers, toast, hard rolls, pretzels, tortillas, pizza, noodles, grits, bagels, rice, oatmeal, corn bread, fried bread, flat bread, and macaroni.

Using the food picture cards, show the children one card at a time. Ask the children to name the food shown on the card. If the children are unfamiliar with the food, name it for them. Ask children to identify their favorite foods of those that have been shown on the cards.

2. Food Comparisons - Give children the opportunity to compare the shapes, colors, and textures of different foods by showing them two food cards selected from the entire group of cards you have made. Ask what is alike and what is different about the foods shown. Repeat the activity using pairs of the remaining cards.
3. Tasting Party - Using foods that the children seemed unfamiliar with when viewing the food cards, plan "tasting parties," giving the children samples of those foods. If possible, bring the food in its original form and show the food item to the children before it is broken into bite-size pieces. Have children discuss how the food feels, looks, tastes, and smells. Some

specific questions you may want to ask include:

"What color is the food?"

"What shape is the food?"

"Is the food soft?" "Hard?"

"Does the food 'crunch' when you eat it?"

"Which teeth do you use to bite it?" "Chew it?"

"Does it taste like any other foods you have eaten?"

If possible, invite parents to participate in your tasting party.

4. Choosing snacks - Begin this activity with the following questions about meals. Note: Since many children will not be familiar with the names of meals or periods of the day, describe an activity the children routinely participate in at that time of the day. For example, for question two, "What do we call the meal we eat in the morning?" we have defined "morning" by adding "right after we wake up." For question three, define "middle of the day" by describing what happens for the children at that time of the day, such as "right before you go home from school."

"What are the names of the meals you eat each day?"

"What do we call the meal we eat in the morning, right after we wake up?"

"What do we call the meal we eat in the middle of the day?"

"What is the last meal we eat during the day?"

"Do you ever eat food between breakfast and lunch?"

"Do you ever eat food between lunch and supper?"

Tell the children that the foods we eat at times other than mealtime are called snacks. Snacks are those foods we eat in between our meals. Ask the children the following questions:

"Do you know that there are some snacks that are bad for our teeth?"

"Do you know what they are?"

So that children can become familiar with various tastes (sweet, sour, salty, etc.) discuss these tastes during meal and snack times. Explain to the children that foods that are sweet should not be eaten as a snack. It is better to eat sweet foods as part of a meal.

The following is a list of good snacks. Find pictures of good snacks and make a poster or bulletin board. Have the children "name" the bulletin board. Give children an opportunity to identify which foods on the bulletin board are their favorite snacks.

Good Snack Examples:

Cauliflower, raw carrot sticks, celery sticks, popcorn, cheese, peanuts, crackers, pretzels, tortilla chips, pita bread, etc.

If possible, end this activity by giving the children a good snack to eat.

5. Snack Preparation:

Give each child a 3- to 4-inch piece of celery on a paper plate. On a table, place the following items:

- \* A container of sugarless peanut butter and/or a container of cheese spread. (There should be enough for each child to stuff his or her piece of celery with.)
- \* A container of sunflower or sesame seeds, or any other seeds or nuts that can be eaten and are available.

Allow each child to make a celery snack by following these instructions:

Using a plastic spreader, stuff each celery stick with peanut butter or cheese spread.

Sprinkle with sunflower or sesame seeds.

When each child has prepared his or her snack, allow the children to eat their snack.

6. Field Trip - To reinforce the concept of the various food groups, arrange for field trips to the following places so the children can develop an understanding of various foods and how they are produced:

- \* Grocery store or market (arrange for special tours of produce and meat departments).
- \* Bakery (to see demonstration of bread baking).
- \* Farm (to see the dairy production, fields of grain, vegetable gardens, and chicken hatchery).

- \* Orchards (to see fruits on trees and vines).
- \* Fishing harbor (to see fish being brought in).
- \* Group Discussion: For an on-going activity, identify and discuss the various foods served during meal and snack time each day.

Note: Contact a representative from your local dairy council - you may write for information and materials available for teaching preschoolers about nutrition.

7. Planting and Growing Foods Activity - If possible, make arrangements to use a plot of ground outside of your classroom to plant vegetables. Consult with a gardener in your area to determine what vegetable plants would most successfully grow in your particular climate as well as during the months of the school year so the children will experience success with their planting activity.

For an indoor activity, vegetables such as short carrots, leaf lettuce, and radishes will grow and flower in trays placed on the windowsill. Consult a greenhouse for vegetable selection and potting instructions for your particular classroom. Give the children frequent opportunities to witness the growth of plants and to share in the responsibility for caring for the garden. At harvest time, give the children the opportunity to taste the food they have grown.

Lesson Review,  
Puppet Story



Hello, girls and boys! I'm so happy to see all your smiling faces again. Did you have fun learning about all those good foods to eat? Can someone tell me the name of a food you tasted here in school? Was it good? You know, there are many great-tasting foods that help you grow strong and stay healthy. We eat some of these foods for breakfast right after we wake up. Do you want to know what I like to eat for breakfast? I like a bowl of cereal with milk. And I put my favorite fruit on top. Who would like to tell me what you like to eat for breakfast? Sounds yummy! Would someone else like to tell me what you like best for breakfast? Sounds good to me!

If you get hungry before lunch-time, there are all kinds of good snacks to eat. Can someone tell me what you like to eat for a snack? That sounds yummy. You might like peanut butter on crunchy celery sticks. Or a slice of cheese and some crackers. Or some popcorn and milk. Would someone else tell me what you like to eat for a snack? Sounds good! A good snack helps you grow strong and will keep your teeth healthy.

But listen, kids! Sweet snacks, like candies and cupcakes, can stick to your teeth. So, if you want a sweet treat, be sure to eat it with your lunch or supper. What do you like best to eat for lunch? Foods like spaghetti and meat sauce? Or tuna fish salad? Or macaroni and cheese? Or a crunchy taco? Or vegetables and rice? Gosh, there are so many good foods to eat that I get hungry just thinking about them. Remember to eat good foods and brush your teeth after you eat. Goodbye, girls and boys. See you again soon!



Parent Letter: "Wise Food Choices For a Healthy Mouth"

Dear Head Start Parent:

A healthy diet is important for your child's growth and development. At Head Start, we choose healthful foods for your child's meals and snacks each day. We also have had classroom activities to teach your child to eat foods that are most healthful.

Every day your child needs at least four servings of fruits and vegetables, four servings of breads and cereals, three servings of dairy products, and two servings of meats. The attached page lists some appropriate foods from each food group.

To help your child have healthy teeth, it is important not to eat too many sugary snacks. Although young children need to eat some snacks because they cannot eat all the foods they need at meals, it is important to choose snacks that do not contain sugars. The following are good choices: cheese, plain yogurt, meat, fish, eggs, peanut butter (without sugar), strips of raw vegetables, pretzels, toast, crackers, popcorn, tacos, dill pickles, nuts, refried beans, pita bread, and tortilla chips.

If sugary foods are eaten, they should be given to your child at the end of the meal rather than as between-meal snacks.

By giving your child a balanced diet and encouraging good eating habits, you can help your child have good dental health. We have also attached a few sugarless recipes for you to try.

Sincerely,

FOOD SELECTIONS FROM  
THE FOUR FOOD GROUPS

Dairy Group



Milk, cheese (Swiss, Cheddar, American, Colby, cottage), and plain yogurt

Meat Group



Nuts, eggs (especially hard boiled), ham, chicken, lamb, tuna, shrimp, turkey, hamburger, hot dogs, peanut butter, roast beef, and refried beans.

Fruit and  
Vegetable Group



Fruits: (Fresh and/or packed in water or natural juice.) Oranges, grapefruits, tangerines, peaches, nectarines, cherries, bananas, strawberries, grapes, melons, avocados, apricots, pineapples, and fruit juices without added sugar.

Vegetables: Salad greens, cauliflower, sweet potatoes, white potatoes, cucumbers, green peppers, tomatoes, radishes, carrots, celery, collards, kale, okra, corn, peas, broccoli, potatoes, and green beans.

Bread and  
Cereal Group



Soda crackers, toast, hard rolls, pretzels, tortillas, pizza, noodles, grits, bagels, rice, oatmeal, corn bread, fried bread, flat bread, Indian fry bread, and macaroni.





## SUGARLESS RECIPES

Snacking on sugar-rich foods contributes to the decay of healthy teeth. The "right kinds" of snacks are more nutritious and less costly. The following are recipe suggestions for lunches, special treats, and celebrations. Help keep your child happy and healthy.

### Nutty Balls

Roll softened cream cheese, Cheddar cheese, or sugarless peanut butter balls in chopped nuts, roasted sesame seeds, or parsley. Chill before serving.

### Stuffed Celery Sticks

Stuff celery with cream cheese or sugarless peanut butter, and top with sunflower seeds, roasted sesame seeds, paprika or caraway seeds.

### Nutty Cheese Cookies

1/4 lb. grated Cheddar cheese  
3-4 Tbs. milk  
1 cup whole wheat flour  
1/3 cup finely chopped nuts  
3 Tbs. oil  
1/4 tsp. salt  
Dash of cayenne pepper

Mix cheese, flour, oil, salt, and cayenne until crumbly. Add milk and nuts. Form into 1-inch balls. Place on oiled cookie sheet and bake at 350° for 20 minutes.

### Individual Pizzas

English muffins  
Tomato sauce  
Grated Mozzarella cheese

Cover half of an English muffin with tomato sauce. Sprinkle grated cheese over the sauce. Broil in oven until cheese melts.

**LESSON:**

**KEEPING TEETH SAFE**

**Purpose:**

To identify ways to prevent accidents that might injure the mouth.

**Materials Needed:**

Activity Pages, "Safety Do's and Don'ts"  
Happy Face stick puppets (see Lesson, "Toothbrushing")  
Emergency Procedures Chart  
Parent Letter, "Keeping Teeth Safe"  
Attachment to Parent Letter, "Dental Emergency First Aid"

**Background Information for the Teacher:**

Accidents in which children injure their teeth or mouth are quite common. To prevent them, children must learn how to identify safety hazards and must learn how to play safely. All of the following are common causes of oral injuries:

- tricycle and bicycle accidents;
- falling over objects on the floor or sidewalk;
- pushing and shoving around water fountains;
- playing carelessly around swings, teeter-totters, merry-go-rounds, and other playground equipment;
- chewing on ice, pencils, or other hard objects; improperly using toothpicks;
- not wearing a seat belt while riding in a car, van, or bus;
- not wearing a mouth protector while playing in sports activities (this applies mainly to older children).

The Dental Emergency Chart on the following page should be posted in your classroom. You may also want to make a copy to send home with the parent letter for this lesson.

In a dental emergency, Head Start staff members should be prepared to administer first aid as well as seek help when necessary. Be sure to have emergency telephone numbers near each phone. When an accident occurs, your first concern should be the injured child. Keep in mind, however, that the other children may be emotionally upset, curious, or concerned. Use the time following the accident to reassure the children, and allow them to share their feelings regarding the accident. Try to use this as a learning opportunity in order to prevent further accidents.



## DENTAL EMERGENCY FIRST AID

In the event of an accident to the tongue, lips, cheeks, or teeth:

Attempt to calm the child.

All incidents should be handled quietly and calmly; a panicked child is likely to create problems for treatment and may cause further trauma.

Check for bleeding. If the child is bleeding:

- a. Stop bleeding by applying pressure to the area;
- b. Wash the affected area with clean water;
- c. Apply ice, wrapped in clean cloth, for swelling.

If tooth is knocked out, fractured, chipped, broken, or loose:

- a. Staff should calm the child.
- b. If injured area is dirty, clean gently.
- c. Place cold compresses on the face, in the injured area, to limit swelling.
- d. Immediately take the child to a dentist for treatment.

If teeth are loosened in an accident:

- a. Rinse out the child's mouth.
- b. Do not attempt to move the teeth or jaw.
- c. Take the child to the dentist immediately.

If a tooth is knocked into the gums:

- a. Do not attempt to free or pull on the tooth.
- b. Rinse out the child's mouth.
- c. Take the child to the dentist immediately.

If injury to the tongue, cheeks or lips occurs:

- a. Rinse affected area.
- b. Apply ice, wrapped in clean cloth, to control swelling.
- c. Take the child to the dentist or a physician if bleeding continues or the wound is large.

In the event of any other soft tissue injury, as in the case where the tongue or lips become stuck to an object and the tissue tears:

- a. Stop the bleeding.
- b. Cover the affected area with sterile petroleum jelly.
- c. Take the child to the dentist or to a physician.

Police \_\_\_\_\_

Fire \_\_\_\_\_

Paramedics \_\_\_\_\_

Physician \_\_\_\_\_

Dentist \_\_\_\_\_

Starting the Lesson:

Begin the lesson by asking the children if they have ever hurt their mouth. If so, ask how the accident occurred. Next, ask students if they could have done something so that the accident would not have happened. Ask students if they know of other people who have hurt their mouth. If so, ask them if they know what might have been done so that the accident would not have occurred.

- A. Hold up section one of Activity Pages, "Safety Do's and Don'ts." Ask children to look at the picture. Ask them what they see in the picture that might cause an accident or injure the mouth. Then have them explain what has been changed in section two of the picture that shows a good safety practice. Continue this procedure with each picture set of the "Safety Do's and Don'ts" pages.
- B. In order to develop an awareness that children should immediately inform an adult of any injury, ask the children the following questions:
  - \* If you were at a swimming pool and you hurt your mouth or teeth, who would you tell? (Elicit responses such as lifeguard, mother, or other adults who might be with the child at the pool or serving as a guard around the pool area.)
  - \* If you were on the playground at school and hurt your mouth, who would you tell? (Elicit responses such as teacher, school nurse, teacher's aide, or older student.)

- \* If you were walking home from school and you hurt your mouth, who would you tell? (Elicit responses such as a school guard, a police officer, a bus driver, or an older person whom the child knows.)
- \* If you were at home and in the backyard and you hurt your mouth, who would you tell? (Elicit responses such as baby sitter, mother, grandparent, relative, neighbor, or an older brother or sister.)

Classroom  
Activity:

1. Safety - Cut out each separate picture on the Activity Pages, "Safety Do's and Don'ts." Mount each scene on a piece of tagboard.

Distribute the "Happy Face" stick puppets to children. Have them hold up the happy face as you display a card that shows a good safety practice. When you hold up a card showing an unsafe practice, children should shake their heads back and forth and say "no." After each card is displayed discuss the safety rule(s) that should be followed to prevent the specific accident.

2. During the Halloween season emphasize safety of the mouth by discussing costume safety, going out with an adult, being able to see through the masks, and being very cautious of foods that are eaten.

Lesson Review,  
Puppet Story



Hello, everyone! Today we're going to talk about something very important - keeping your teeth and mouth from getting hurt. Has anyone ever bumped a tooth while playing? Would you like to tell me how it happened? Has anyone else ever bumped a tooth or hurt their mouth? Could you tell me how it happened? We must try very hard to keep our teeth and mouth safe. I don't want any of you special boys and girls to get hurt.

We can do many things to keep our mouth and teeth safe. I always put away my toys when I'm finished playing. Do you know why? That's right! Then no one can trip over them and bump a tooth. And I never put a toy or anything except food into my mouth. Do you know why? Very good! Hard things, like toys, can hurt our gums or chip our teeth.

Now, let's pretend you're outside. You're playing with some other children when, all of a sudden, you fall down and bump your tooth. Who would you go to for help? (Parent, grandparent, older sister or brother, baby sitter) Very good! It's important to tell someone you know. Well, boys and girls, remember to be careful when you're playing. If you ever get hurt, be sure to tell someone you know right away. Have to go now. Goodbye, kids!



Parent Letter: "Keeping Teeth Safe"

Dear Head Start Parent:

Accidents to the teeth or mouth are common among young children. Today your child learned how to prevent accidents by following good safety habits. For example, if children put their toys away after play, no one can trip and fall on them.

Ask your child to go through your home with you to help you point out possible sources of accidents. Then discuss how these might be eliminated. Set up a list of safety rules you both must follow.

By helping your child think about safety, you can reduce the child's risk of injuring his or her mouth.

Sincerely,



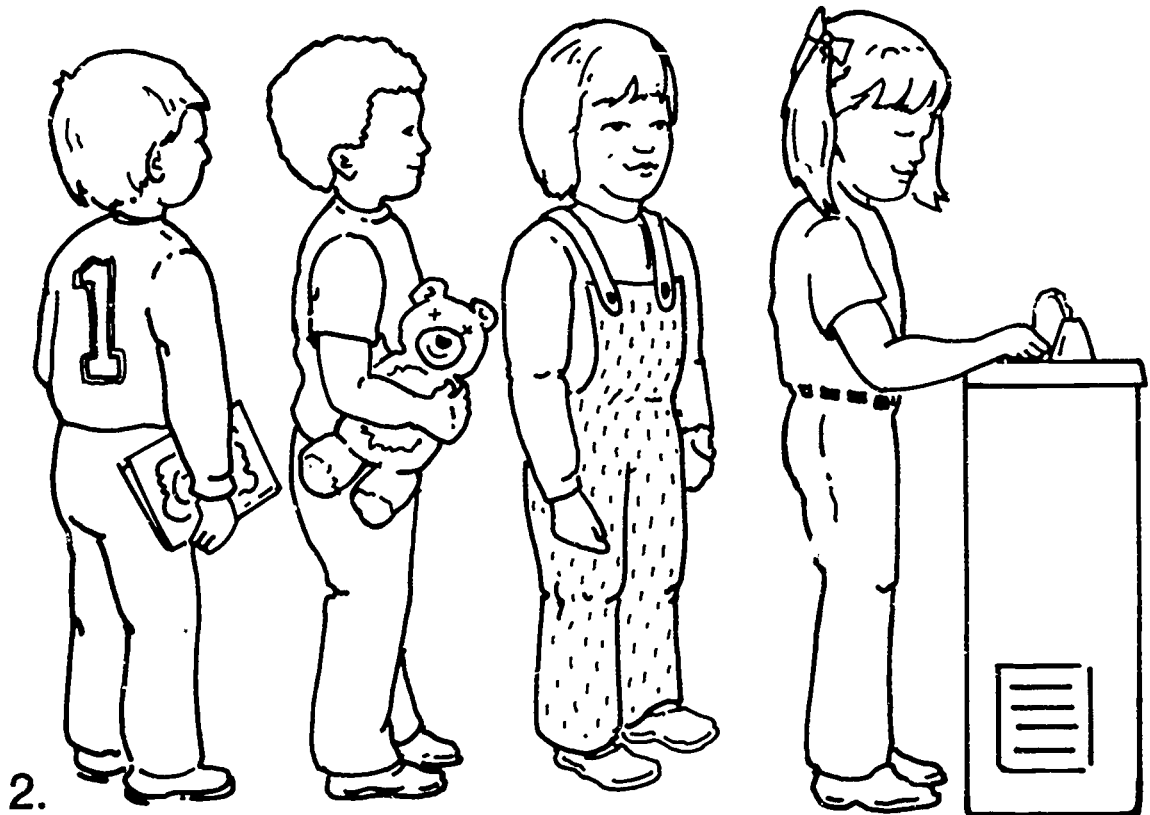
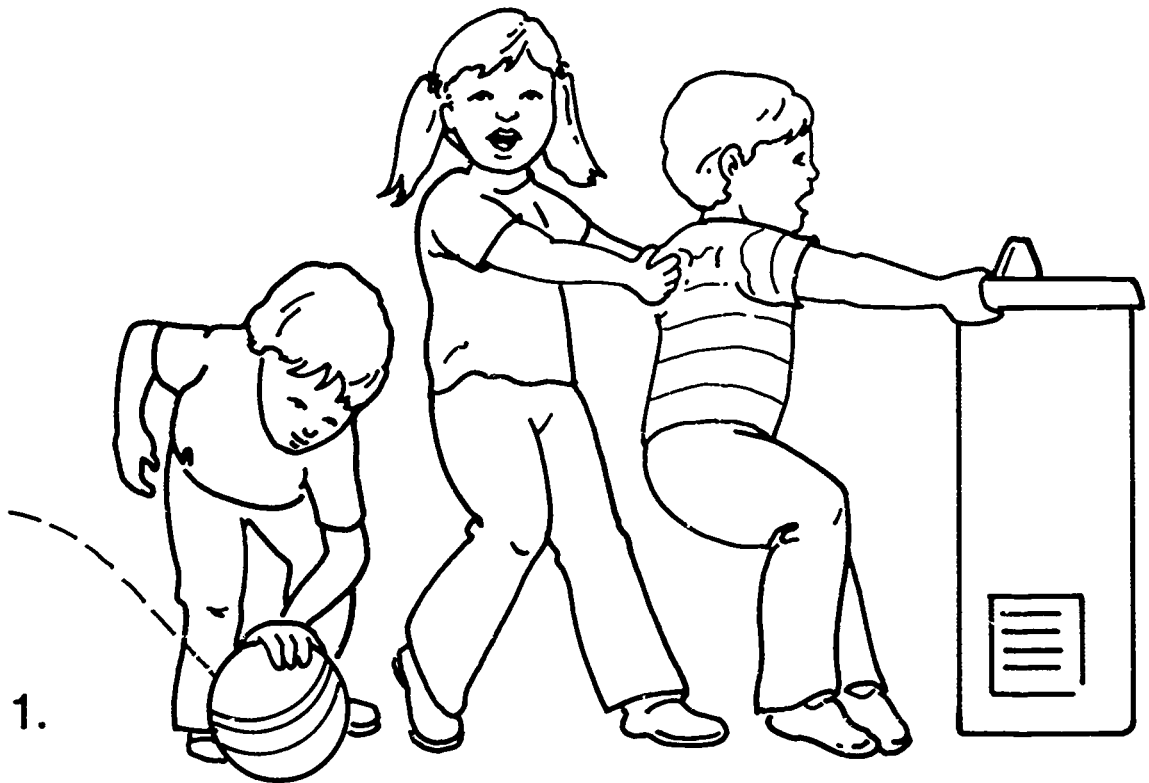

1.



2.



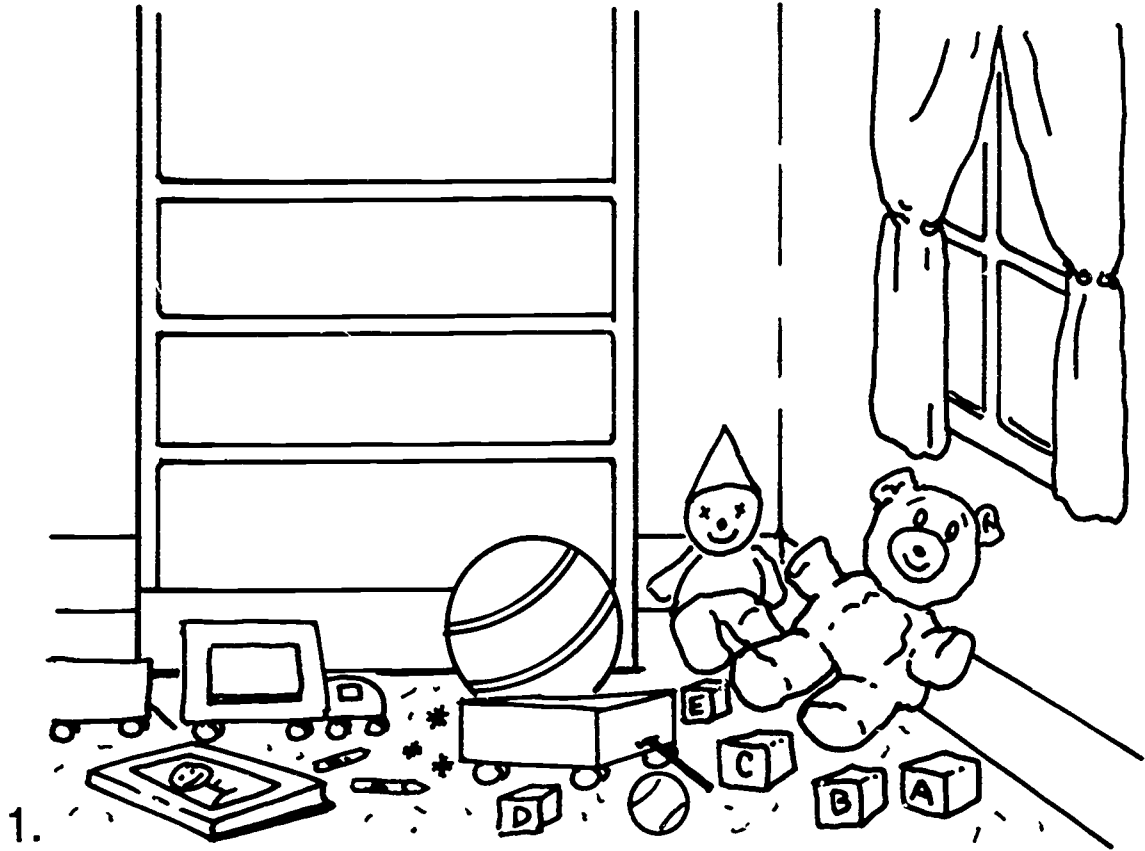

**LESSON:**

**REINFORCEMENT ACTIVITIES FOR  
DENTAL HEALTH**

**Purpose:**

To reinforce prevention-oriented dental health concepts and practices at home and at school throughout the school year and after children leave Head Start.

**Materials Needed:**

Mirrors  
Cassette tape  
Cassette recorder  
Index cards  
Activity Pages, "Dental Memory Game"  
Parent Letter, "Reinforcement Activities for Dental Health"

**Background  
Information  
for the Teacher:**

After the children have completed the unit on dental health, the information should be reinforced throughout the year. This helps keep the children's interest in the subject alive and encourages them to develop the daily habits needed for good dental health.

Many teachable moments exist within the Head Start program to incorporate dental health concepts. A teachable moment is any unplanned opportunity to develop or reinforce a learning concept.

For example, during the daily meal or at snacktime you may discuss dentally healthful snacks as well as the texture, color, and taste of various foods. This provides an easy way to remind the children of what they have learned regarding dental health. Children can be given dental puzzles, games, songs, and other similar activities. Local libraries may have attractive books on teeth. Local museums may have dental or health dis-

plays the children will find interesting. Members of the dental community are often willing to visit your classroom to talk to the children about dental subjects.

**Classroom  
Activities:**

1. Place a mirror at the children's eye level so that they can inspect their smile on a daily basis.
2. Make a cassette recording of the children singing the songs that they have learned about dental health. Play the recording throughout the year on a portable cassette player as the children brush their teeth.
3. As the children are brushing each day, be sure to remind them of all the areas of the mouth that should be cleaned. Say such things as, "Be sure to clean all the outside surfaces of the teeth, all the inside surfaces of the teeth, and the chewing surfaces of the teeth, both top and bottom." Try to use the following phrases with the children to reinforce their brushing habits and to develop positive self-concepts:  
  
"You're doing a good job." "Your teeth look sparkling." "What a nice smile you have." "You're a very good brusher." "I like looking at your clean smile." "You should be proud of what a good job you've done cleaning your teeth." Etc.
4. During meal and snack time discuss the kinds of foods that are being eaten, what color the foods are, what texture the foods are, the flavor of the foods, and the shape of various foods. Ask the

children to describe good food/  
snack choices for good dental  
health.

5. During lessons about animals,  
take time to discuss the shapes  
of the animal's teeth and how the  
animal uses its teeth.
6. Provide copies of magazines for  
children to look through. En-  
courage them to cut out pictures  
of attractive smiles, and make  
collages showing all the pictures  
they have selected.
7. Keep a classroom brushing chart  
(and, where applicable, a  
fluoride chart), and have the  
children put a star by their name  
every day after they have cleaned  
their teeth and/or used fluoride  
(where applicable).
8. Card game -- Using the pictures  
that are shown on Activity Pages,  
"Dental Memory Game," cut out and  
paste the individual pictures on  
index cards.

Instruct a small group of chil-  
dren to play a memory game by  
placing all the cards face down  
on a table. Each child, in turn,  
turns over one card and then at-  
tempts to locate the matching  
card. If two cards match, the  
child keeps the set and gets  
another turn. The child with the  
most matching sets at the end of  
the game is the winner.

Note: It is important to work  
with the children individually to  
determine how many sets they can  
successfully play with. Some  
children may be able to remember  
only three or four sets of  
cards. It is better to have only  
a few sets in order for the chil-  
dren to experience success.

Before the children play this game, be sure to identify the objects illustrated on the cards so you can be certain the children are familiar with the items.

9. On a field trip to the local library, make arrangements for the librarian to read a story to the children that has to do with teeth or dental health.
10. Check with the museums in your area to see if they have a special dental health exhibit. Make arrangements to visit that specific exhibit during a field trip to the museum.
11. If there is a health center in your community, check to see if its staff provide special dental programs for preschool children. If so, make arrangements for your children to participate.
12. Contact the members of the auxiliary to the dental society, dental hygienists, or dental assistants to find out if they have special programs that they will conduct for young children. Representatives from these groups may be found by contacting the local dental society and asking them for the name and number of a person you can call.
13. Contact the public health department in your area to find out if it has special programs about dental health that its staff will present to preschool children. The public health department number may be found in the telephone directory under the city, state, or county health department listing.

14. If there are colleges or universities in your area, contact the health education department or, if available, the dental school and ask about setting up a program on dental health for your students. Students of health education, dentistry, dental hygiene and dental assisting may be willing to assist you with some part of your dental program or be a special guest speaker in your classroom.
15. During National Children's Dental Health Month (February), invite a member of the dental community to visit the classroom. For assistance in finding someone to visit your classroom call the dentist on the Head Start Health Advisory Committee, or call the local dental association or society. The number may be found in the telephone book.
16. During the month of February, incorporate a National Children's Dental Health Month activity with a Valentine party. For a Valentine's Day activity, have children draw smiling faces on heart-shaped paper. The drawings may be displayed on a bulletin board or exchanged among the students as their Valentines to one another.
17. Serve dentally healthful snacks for cultural and ethnic holiday observances throughout the year.



Lesson Review,  
Puppet Story



Hi, boys and girls. Didn't we have fun together learning about our teeth? I hope you will always take good care of your teeth to keep them healthy and strong. What are some of the things we should do to take good care of our teeth? Very good! We should brush them every day. We should use a fluoride toothpaste. We should eat good foods. We should be careful not to hurt our teeth when we play. And we should visit our dental helper friends for checkups. Well, it's time for me to go. But before I leave, let's sing one of our little songs together. It's called "Smiles We See."



Parent Letter: "Reinforcement Activities for Dental Health"

Dear Head Start Parent:

Your child's Head Start class has been learning about dental health. Throughout the year, we will continue to remind the children of what they have learned about their teeth and mouth so that they will continue to care about their dental health.

Please be sure to remind your child at home of the importance of the following rules for good dental health:

1. Brush the teeth thoroughly with fluoride toothpaste every day.
2. Eat a balanced diet and don't eat too many snacks.
3. Visit the dentist as often as he or she suggests.

Although your child is too young to floss his or her teeth, you will want to check with your dentist or hygienist to learn the best way you can floss his or her teeth. Also be sure to ask about the use of fluoride to make your child's teeth more resistant to decay and about sealants to prevent decay in the chewing surfaces of the back teeth.

Remember, your child imitates the things you do. By taking care of your teeth and gums, you are setting a good example for your child to follow. Dental disease can be prevented! Most children start out with strong, healthy teeth--help make sure that your child's teeth stay that way.

Sincerely,



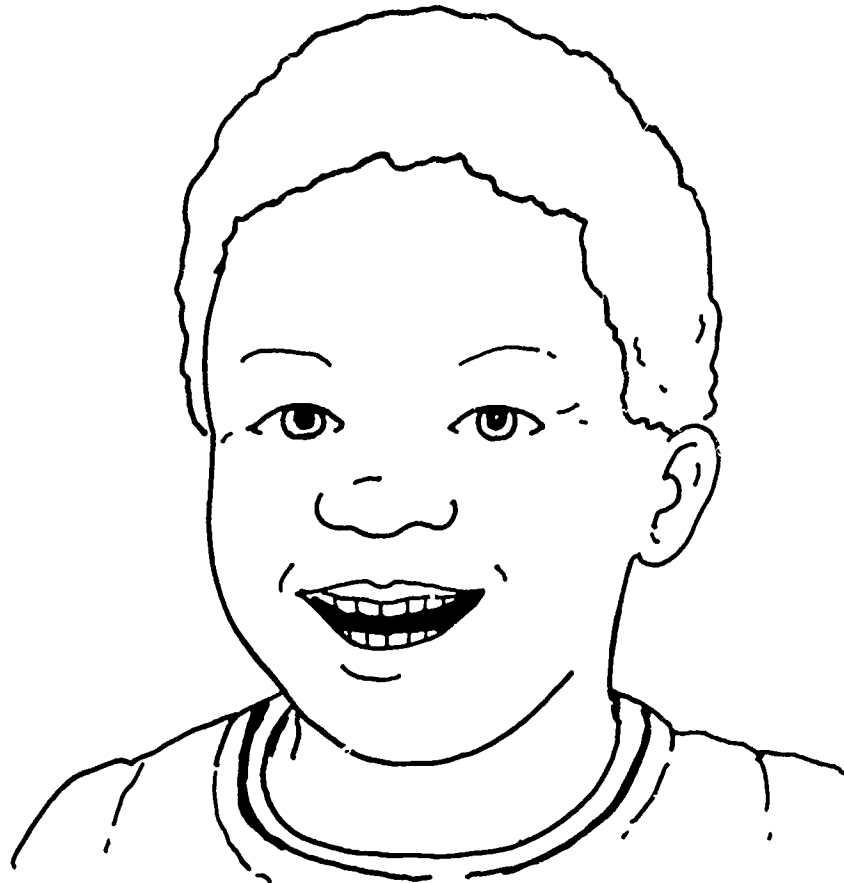
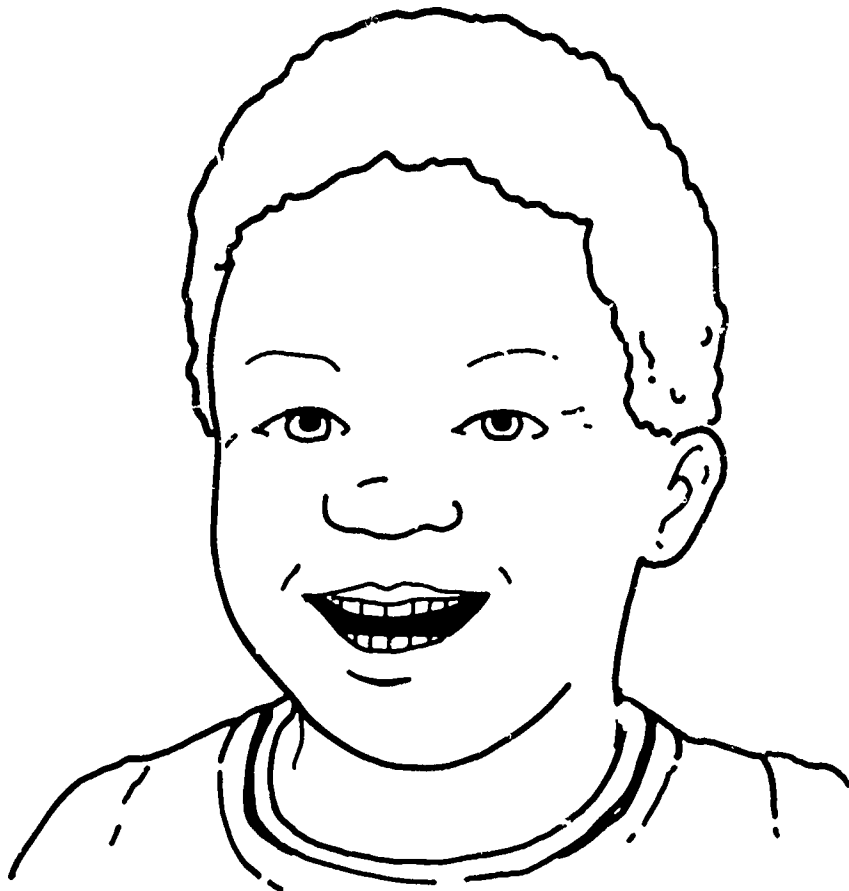



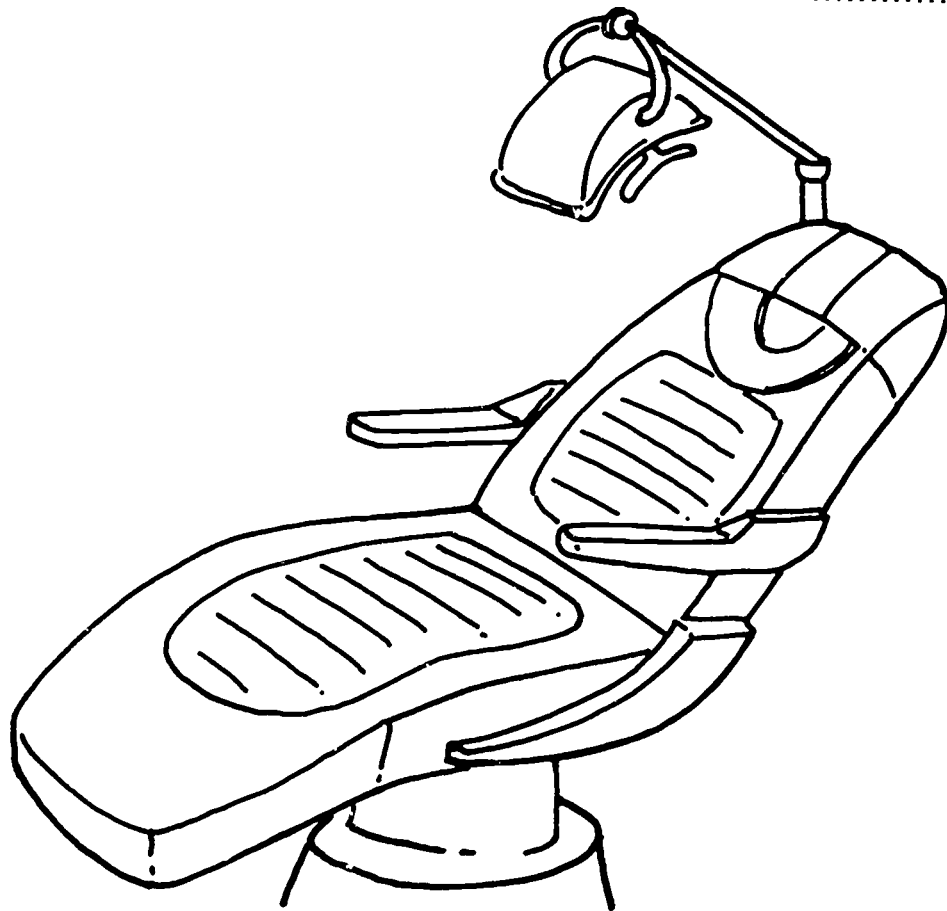
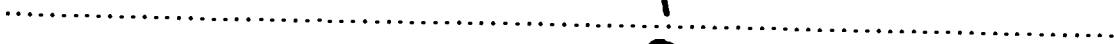
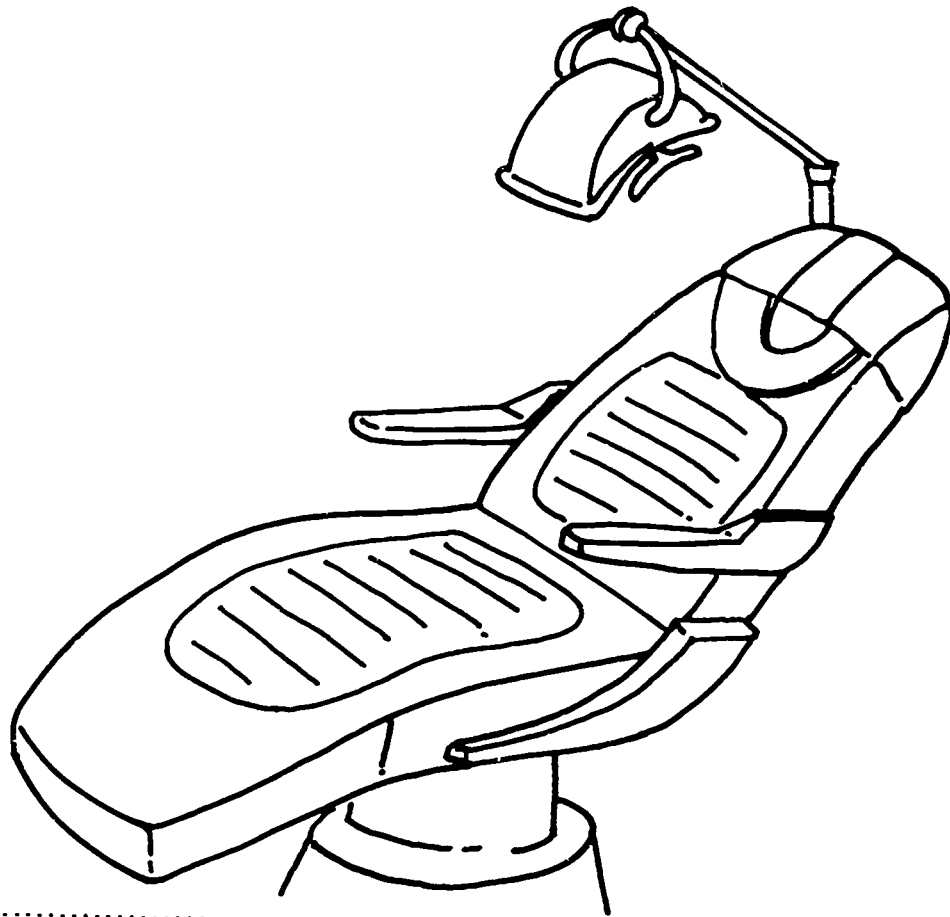

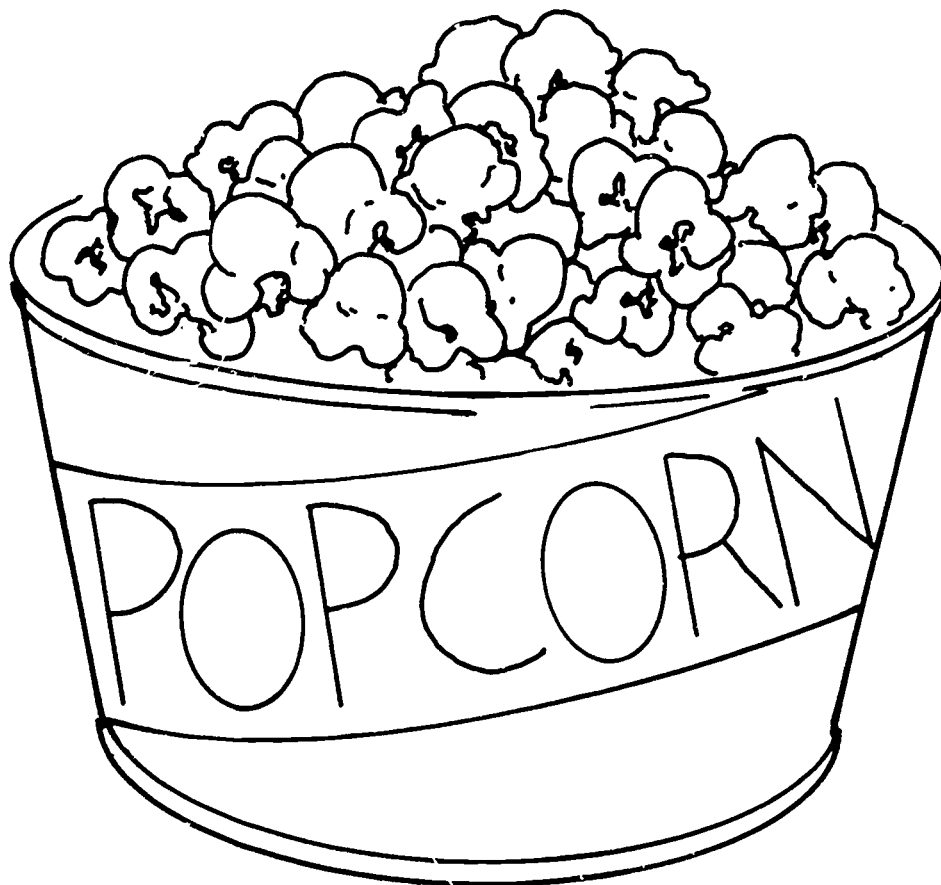
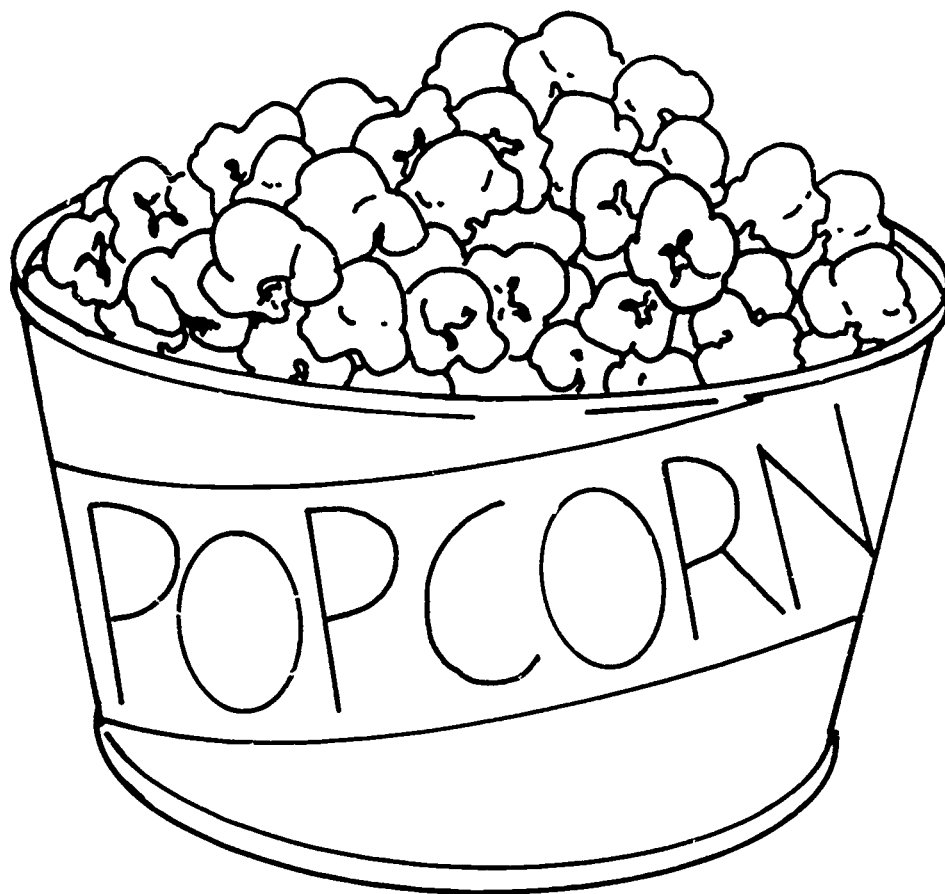

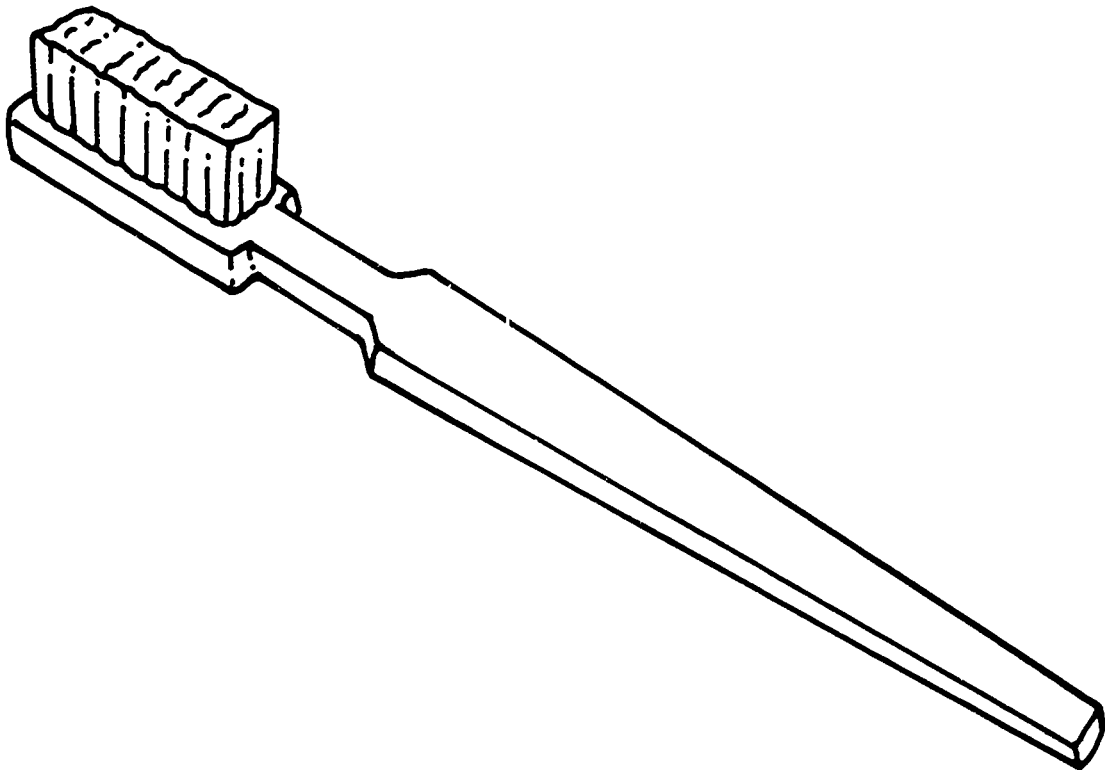
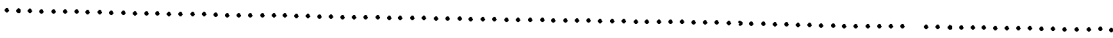
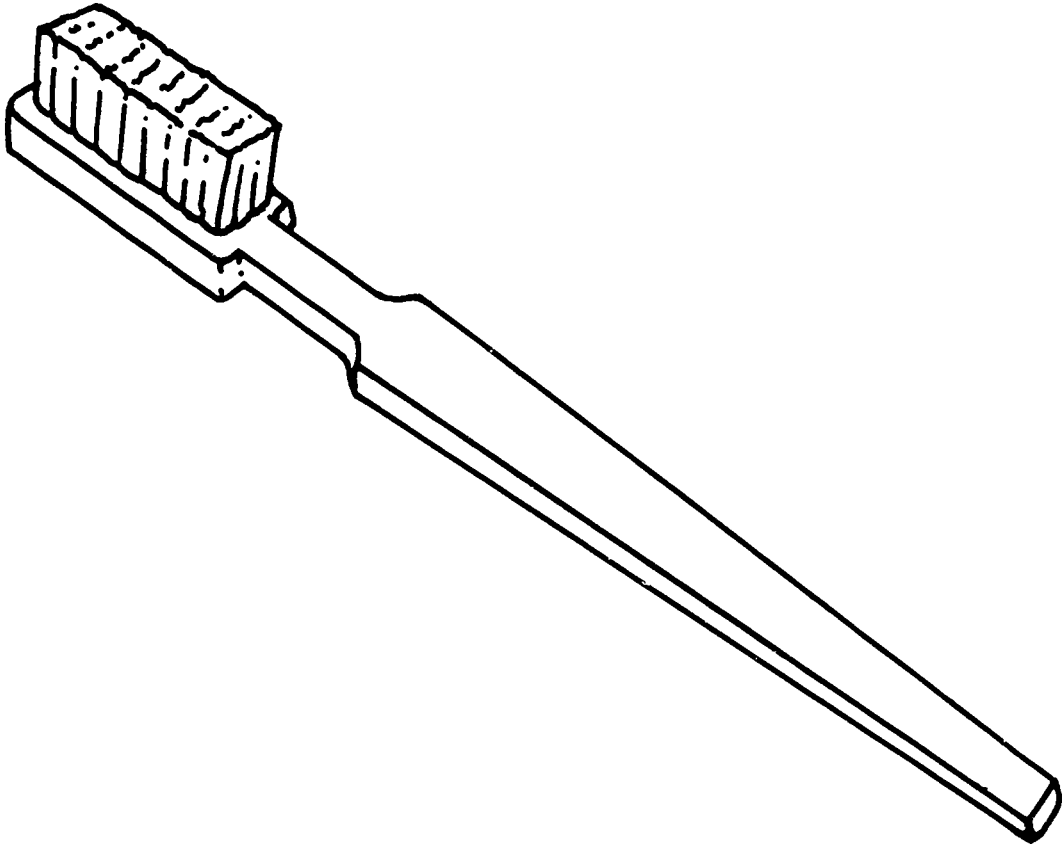



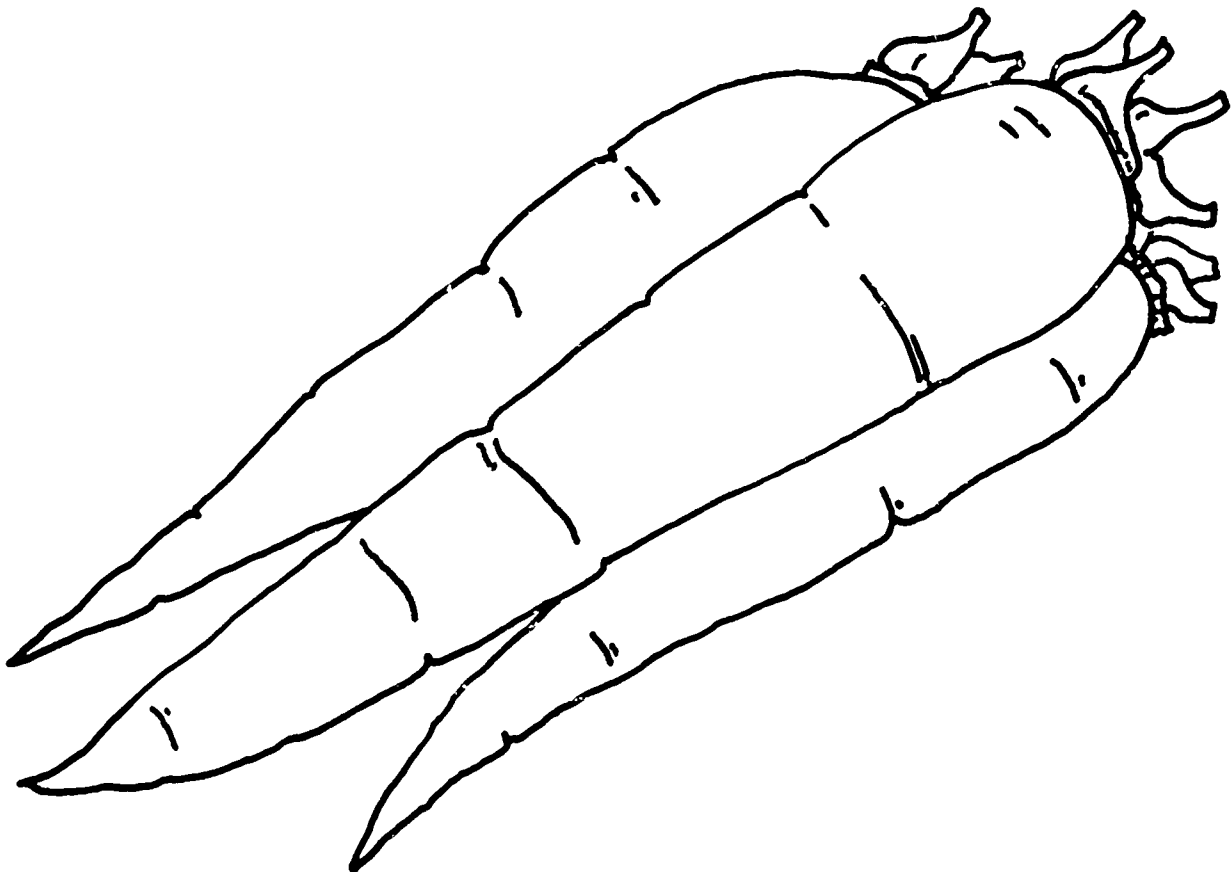
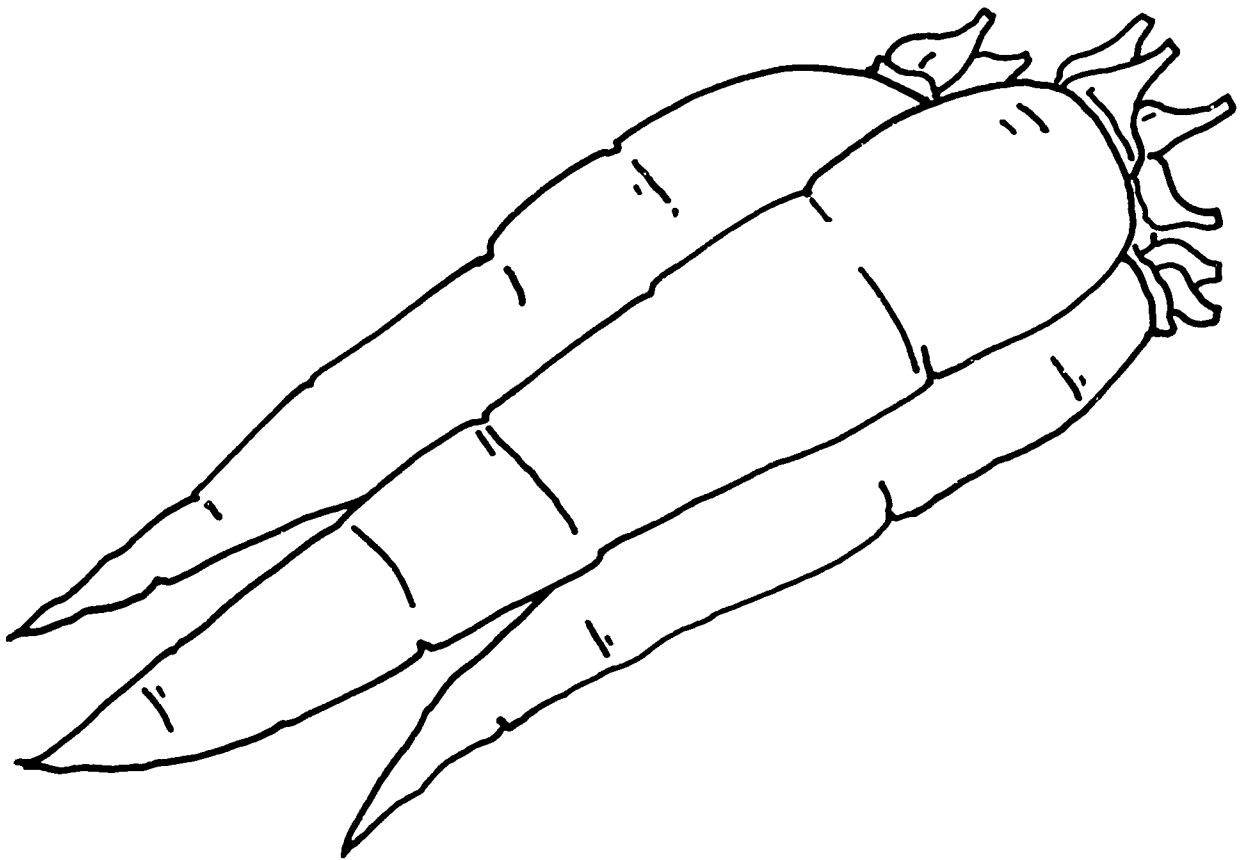





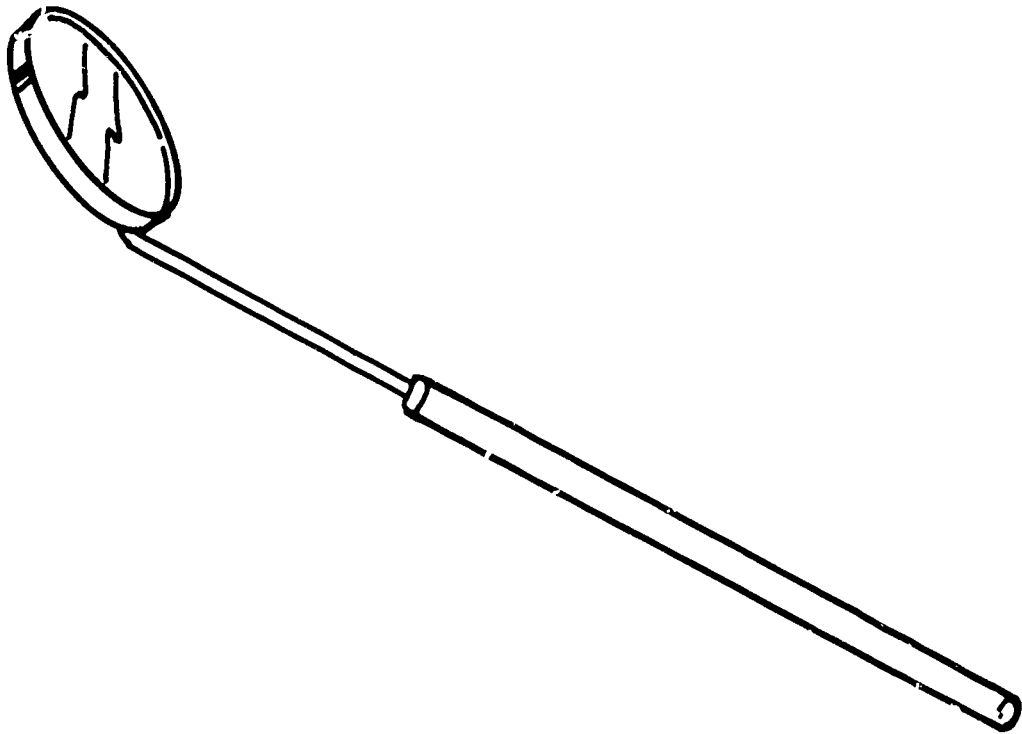
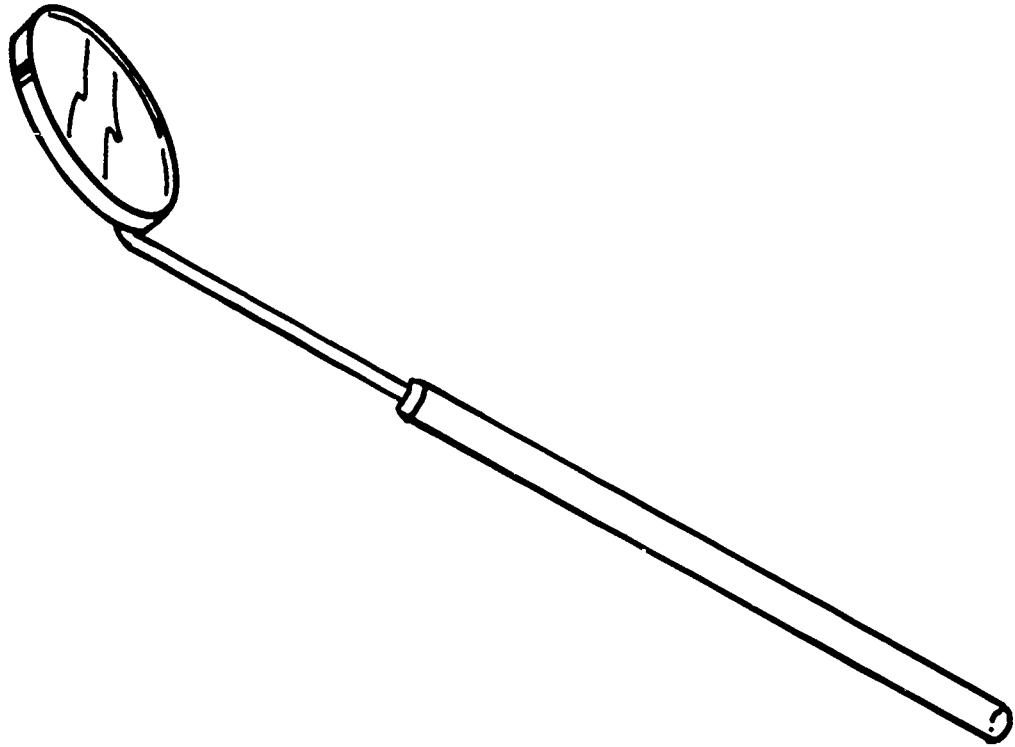

## RESOURCES

Following is a list of national organizations that may have dental-related materials for use with this program. In some instances, an organization may not have materials but may have local societies whose members might be willing to serve as resource persons for your dental health program. Check your telephone directory for the local society nearest you. If you are unable to find a listing for a local society, you can contact the national organization for the address and phone number of its local society in your area.

American Academy of Pediatric Dentistry  
211 East Chicago Avenue, Suite 1036  
Chicago, Illinois 60611  
312-337-2169

American Dental Assistants Association  
666 North Lake Shore Drive, Suite 1130  
Chicago, Illinois 60611  
312-664-3327

American Dental Association  
Bureau of Health Education and Audiovisual Services  
211 East Chicago Avenue  
Chicago, Illinois 60611  
312-440-2593

American Dental Hygienists' Association  
444 North Michigan Avenue, Suite 3400  
Chicago, Illinois 60611  
312-440-8900

American Society of Dentistry for Children  
211 East Chicago Avenue, Suite 920  
Chicago, Illinois 60611  
312-943-1244

Auxiliary to the American Dental Association  
211 East Chicago Avenue  
Chicago, Illinois 60611  
312-440-2865

National Dairy Council  
6300 North River Road  
Rosemont, Illinois 60018  
312-696-1020

National Dental Association  
National Dental Hygienists Association  
National Dental Assistants Association  
5506 Connecticut Avenue, NW, Suite 24-25  
Washington, DC 20015  
202-244-7555

National Foundation of Dentistry for the Handicapped  
1250 14th Street, Suite 610  
Denver, Colorado 80202  
303-573-0264

National Institute of Dental Research, N.I.H.  
Building 312C34  
Bethesda, Maryland 20205  
301-496-4261

U.S. Department of Agriculture  
Food and Consumer Services  
Human Nutrition Information Service  
Presidential Building  
6525 Belcrest Road  
Hyattsville, Maryland 20782  
301-436-7725

U.S. Department of Health and Human Services  
Office of Human Development Services  
Administration for Children, Youth and Families  
400 Sixth Street, SW  
Washington, DC 20013  
202-755-7762

Your state, county, or municipal health department's  
division of dental health services

### HOME VISIT ACTIVITIES:

If you have the opportunity to visit the home or if your program includes a home visit component, the following activities may be conducted to reinforce good dental practices by the family members.

1. Assist parents in preparing and/or selecting nutritious and dentally healthful snack recipes.
2. Assist parents in making recipe cards for good snack recipes.
3. Assist parents in making a family brushing chart. List every family member on the chart, and encourage parents to work with their children on marking the chart each day following brushing.
4. Explain to parents that it is important to reinforce their children's dental health habits. To reward good dental behavior and to help build the self-esteem of their children, encourage parents to say the following to their children:  
  
"You do a very good job of cleaning your teeth."  
"I'm proud of the way you clean your teeth so well."  
"You have such a nice smile, I'm glad you brush your teeth so well."  
"You're special! I'm glad you take such good care of yourself."  
"I'm proud of your good snack choices."
5. Conduct a family "Brush-In" to teach family members the proper brushing skills.
6. Arrange for a dental professional to visit the family with you to demonstrate proper dental care techniques.
7. Conduct a safety check at home for potential hazards to oral health. After the check is made, help the family write safety rules for the home. Encourage parents to write each rule on a separate piece of paper, and let their children draw pictures on the safety rule page.
8. Advise parents that they should not give a bottle of milk, formula, or juice to children at nap or bedtime. The liquid around the child's teeth may lead to decay. Only plain water should be used in bottles at nap or bedtime.

9. Describe the methods of obtaining fluoride at home. Create an awareness of the ADA Seal of Acceptance on dental products. Encourage parents to select such dental products.
10. Give parents a list of the four food groups and examples of foods in each group. Discuss the importance of a well-balanced meal. Work with parents on the development of menus for their family. Be aware of favorite food items, and include them in the menus.
11. Advise parents of the dental hazards of frequent snacking. Provide a list of sensible snacking choices.
12. If possible, take parents with children on a field trip to the dental office. Arrange for a dental professional to describe the procedures that are followed during the child's first dental visit.



## YOUR ROLE IN HELPING CHILDREN WITH DISABILITIES CARE FOR THEIR DENTAL HEALTH

Following is information on caring for the disabled child's dental health. Please follow these suggestions in the dental care of disabled students that you have. If possible, make a copy of these suggestions for parents of your disabled students.

### TEACHING CHILDREN WITH SPECIAL PROBLEMS

Preventive dental care may be difficult for children with disabilities. The "simple" techniques of keeping teeth clean can be quite difficult for handicapped children. Often a toothbrush must be adapted for the child with a handicap. The dental profession suggests the following modifications:

#### Holding the toothbrush:

Attach the brush to the hand with a wide elastic band, or bond a fingernail brush handle to the toothbrush.

Enlarge the handle with a sponge, piece of styro-foam, rubber ball, bicycle handle grip, or similar item.

Lengthen the handle with a piece of wood or plastic to aid those with limited shoulder movement.

Bend the brush handle after warming it. Vigorously rub the brush for a minute or run hot tap water over the handle (not the head). (This procedure may not work for all toothbrushes.) Then bend the brush handle into position to clean the child's teeth.

#### What Positions Can Be Used?

If an adult must clean the child's teeth, the child's dentist and physician should be consulted when deciding what position to use. Not all positions are safe for all children. Some possible positions are:

The child sits on a high chair or in a wheelchair and the adult stands behind, using an arm to hold the child's head against the chair or against the adult's body.

The child then tilts the head back. A pillow behind the child's head may be used to make this position more comfortable. (This position

should not be used for children who drool, gag easily, or cannot control swallowing.)

The child sits on the floor and leans the head and shoulders back against the knees of the adult, who sits in a chair. (This position is not suitable for children who need lateral support.)

The child lies on the floor, head on a pillow, and the adult kneels behind the child's head. An arm can be used to hold the child still, if needed.

The child lies on a bed or sofa, head in the adult's lap. An arm can be put around the child's head and shoulders for support. (This position is useful for the child who is uncooperative or whose movements are uncontrolled, as a second person can hold the child's hands or feet.)

The child sits in a beanbag chair, which allows relaxation without fear of falling. The adult sits or kneels near the child's head. An arm can be used to hold the child still, if needed. (This position is useful for the child who is uncooperative or whose movements are uncontrolled, as a second person can hold the child's hands or feet.)

If using a position in which the child leans back, take care to avoid choking or gagging the child. Toothpaste need not be used, but the brush should be rinsed often and the child should rinse out his or her mouth when brushing is finished. When the teeth are clean, a little fluoride toothpaste can be put on the brush and spread over the teeth, or a fluoride mouthrinse can be used. This will help prevent decay by giving the teeth some of the fluoride protection they need.

## GROUPS WORKING WITH THE DISABLED

If you need information or help in locating a dentist who works with the disabled, several groups may be of assistance:

Academy of Dentistry for the Handicapped  
211 East Chicago Avenue  
Chicago, Illinois 60611  
312-440-2660

American Academy of Pediatric Dentistry  
211 East Chicago Avenue, Suite 1235  
Chicago, Illinois 60611  
312-337-2169

American Dental Association  
Bureau of Health Education and  
Audiovisual Services  
211 East Chicago Avenue, Suite 1616  
Chicago, Illinois 60611  
312-440-2593

American Society of Dentistry for Children  
211 East Chicago Avenue, Suite 920  
Chicago, Illinois 60611  
312-943-2344

United Cerebral Palsy Association  
66 East 34th Street  
New York, New York 10016  
212-481-6300

National Foundation of Dentistry for the  
Handicapped  
1250 14th Street, Suite 610  
Denver, Colorado 80202  
303-573-0264

Your local dental society  
(Check in your phone book or write to  
the American Dental Association for  
the address of the dental society near you.)

UNITED STATES PUBLIC HEALTH SERVICE REGIONAL  
HEAD START DENTAL DIRECTORS

Listed below are the names and addresses of the Public Health Service Regional Head Start Dental Directors for each of the ten Public Health Service Regions. The States included in each Region are also indicated.

Region I - (Connecticut, Maine, Massachusetts,  
New Hampshire, Rhode Island, Vermont)

Dr. Robin Lawrence  
Public Health Service  
JFK Federal Building, Room 1401  
Boston, Massachusetts 02203

Region II - (New Jersey, New York, Puerto Rico,  
Virgin Islands)

Dr. Jan Richard Goldsmith  
Public Health Service  
26 Federal Plaza, Suite 3302  
New York, New York 10278

Ms. Lucille Adlerstein  
Public Health Service  
26 Federal Plaza, Suite 3306  
New York, New York 10278

Region III - (Delaware, District of Columbia,  
Maryland, Pennsylvania, Virginia,  
West Virginia)

Dr. Robert Selwitz  
Public Health Service  
P.O. Box 13716  
Philadelphia, Pennsylvania 19101

Region IV - (Alabama, Florida, Georgia, Kentucky,  
Mississippi, North Carolina, South  
Carolina, Tennessee)

Dr. Thomas McDermott  
Public Health Service  
101 Marietta Tower, Suite 1202  
Atlanta, Georgia 30323

Region V - (Illinois, Indiana, Michigan, Minnesota,  
Ohio, Wisconsin)

Dr. William Hall  
Public Health Service, Room 3300  
300 South Wacker Drive  
Chicago, Illinois 60606

Region VI - (Arkansas, Louisiana, New Mexico,  
Oklahoma, Texas)

Dr. Jerry Gribble  
Public Health Service, Room 17-35  
1200 Main Tower Building  
Dallas, Texas 75202

Region VII - (Iowa, Kansas, Missouri, Nebraska)

Dr. Lawrence Walker  
Public Health Service, Fifth Floor West  
601 East 12th Street  
Kansas City, Missouri 64106

Region VIII - (Colorado, Montana, North Dakota,  
South Dakota, Utah, Wyoming)

Dr. John Elliott  
Public Health Service, Room 492  
1961 Stout Street  
Denver, Colorado 80294

Region IX - (American Samoa, Arizona, California,  
Guam, Hawaii, Nevada, Pacific Trust  
Territories)

Dr. Reginald Louie  
Public Health Service  
50 United Nations Plaza  
San Francisco, California 94102

Region X - (Alaska, Idaho, Oregon, Washington)

Dr. Sherman Cox  
Public Health Service  
2901 Third Avenue  
Seattle, Washington 98121

## QUESTIONNAIRE

### Dental Health Education Curriculum for Use with Head Start Children and Families

Please complete this questionnaire and return it to:

Bureau of Health Education  
American Dental Association  
211 East Chicago Avenue  
Chicago, Illinois 60611

1. In general, I found this program to be:
  - a. Very useful
  - b. Somewhat useful
  - c. Not useful

Comments:

2. Please indicate whether the following sections of the lessons were very useful (1), somewhat useful (2), or not useful (3):

	Very useful	Somewhat useful	Not useful
Purpose of Lesson	1	2	3
Materials Needed	1	2	3
Background Information	1	2	3
Starting the Lesson	1	2	3
Classroom Activities	1	2	3
Lesson Review, Puppet Story	1	2	3
Parent Letters	1	2	3

Comments:

Please indicate ways the program could be changed to make it more useful:

Please describe in the space below other dental health activities that you have successfully conducted with your Head Start children and that you believe would be good to include in a revised edition of this guide:

Thank you for taking time to give us your feedback.

---

Name:

---

Address of Head Start Center:

---

**U.S. DEPARTMENT OF  
HEALTH AND HUMAN SERVICES**  
Washington, D.C. 20201

OFFICIAL BUSINESS  
PENALTY FOR PRIVATE USE, \$300

Postage and Fees Paid  
U.S. DEPARTMENT OF H.H.S.  
HHS-393



**SPECIAL FOURTH-CLASS RATE**

